

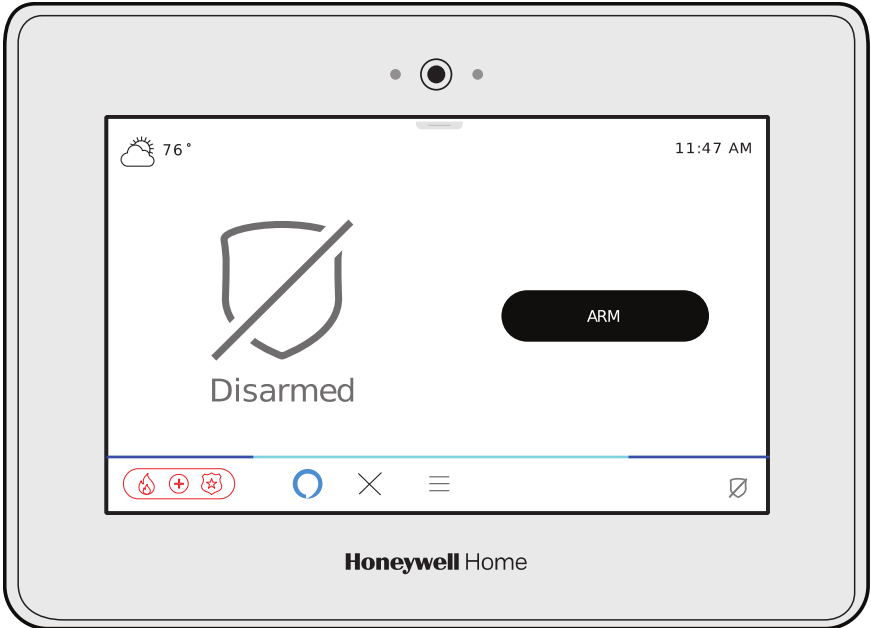

PROA7/PROA7PLUS Series

User Guide



IMPORTANT!

Proper Intrusion Protection

For proper intrusion coverage, sensors should be located at every possible point of entry to a home or commercial premises. This would include any skylights that may be present, and the upper windows in a multi-level building.

In addition, we recommend that radio backup be used in a security system so that alarm signals can still be sent to the Central Monitoring Station in the event that the internet connection is interrupted or not working correctly (alarm signals are normally sent over the Wi-Fi and Internet network).

Early Warning Fire Detection

Early warning fire detection is important in a home. Smoke and heat detectors have played a key role in reducing fire deaths in the United States. With regard to the number and placement of smoke/heat detectors, we subscribe to the recommendations contained in the National Fire Protection Association's National Fire Alarm Code (NFPA 72).

System Compatibility Notice

Your Resideo security system is designed for use with devices manufactured or approved by Resideo Technologies, Inc., through its subsidiary Ademco Inc. ("Resideo"), for use with your security system. Your security system is not designed for use with any device that may be attached to your security system's keypad or other communicating bus if Resideo has not approved such device for use with your security system. Use of any such unauthorized device may cause damage or compromise the performance of your security system and affect the validity of your Resideo limited warranty. When you purchase devices that have been manufactured or approved by Resideo you acquire the assurance that these devices have been thoroughly tested to ensure optimum performance when used with your security system.

About this Manual

This manual is will acquaint you with the system's features and benefits. It defines the components and their functions, describes their operation, and provides clear step-by-step instructions for normal and emergency procedures. Keep this manual in a convenient place so that you can refer to it as necessary

Table of Contents

GETTING TO KNOW YOUR SYSTEM	1
Introduction	1
About This Guide	1
General Information	1
Features.....	1
False Alarm Prevention.....	2
The Home Screen.....	3
Status LED Indications	3
Arming Modes and Status Displays.....	3
Menu.....	4
Menu Features.....	4
OPERATING THE SECURITY SYSTEM	5
Understanding Your Sensors	5
Adding User Codes	6
Arming Your Single Partition System.....	7
Disarming Your Single Partition System	10
Unbypassing Sensors	10
Display & Audio Settings	10
Arming Your Multi-Partitioned System	11
In Case of an Alarm	11
Panic Alarms.....	14
Alerts	15
Activity Log	16
System Information	18
Weather	18
Cameras	19
Wi-Fi Setup.....	20
AUTOMATION	22
Introduction to Automation	22
Adding Automation Devices	23
Removing Automation Devices	24
Scenes.....	26
Alexa.....	27
Bluetooth Disarm.....	28
MAINTENANCE	29
Software Updates.....	29
Screensaver.....	29
Testing the Sensors	30
Testing the Communicators.....	31
System Battery.....	31
Sensor Batteries	31
WIRELESS TOUCHSCREENS, KEYPADS, & KEY FOBS.....	32
PROWLTOUCH Wireless Touchscreen	32
PROSiXLCDKP Wireless Alpha Keypad	33
Wireless Key Fobs	35
PROSiXFOB Wireless Key Status Indications	35
NFPA RECOMMENDATIONS	36
REGULATORY AGENCY STATEMENTS	38
YOUR SYSTEM INFORMATION	40
System Users.....	41
Sensor List.....	43
Z-Wave Automation Devices.....	49
LIMITATIONS OF THIS ALARM SYSTEM.....	51

Introduction

Congratulations on your ownership of the Resideo PROA7/PROA7PLUS 7" Touchscreen Partitioned Security & Automation System. You've made a wise decision in choosing it, for it represents the latest in security protection technology today. Millions of premises are protected by Resideo systems.

Your new system provides:

- Four forms of protection: burglary, fire*, carbon monoxide*, and emergency.
- At least one Keypad or Touchscreen, which provides control of system operation and displays the system's status.
- Various sensors for perimeter and interior burglary protection.
- Automation with various Z-Wave devices such as light switches, plug in modules, thermostats, door locks, etc.

Your system may also have been programmed to automatically send alarm or status messages over the internet or cellular network to a Central Station.

* Commercial installations and some residential systems may not include fire or carbon monoxide protection – check with your Dealer.

About This Guide

This User Guide has intuitive, step-by-step instructions that takes you through many features and operations of your new Security and Automation system. Although it can be printed, this guide is designed for optimal use with a PDF reader program such as Adobe Acrobat Reader. The illustrations in this manual may differ slightly from your system. Also, please note that the term "Control Panel" is used when referring to your new "PROA7/PROA7PLUS".

General Information

The PRO7APLUS Control Panel combines a security system and home automation with an easy to use interface. All functions can be operated from the Control Panel or Touchscreen and many features can be remote controlled from internet-connected smart devices with the use of the Total Connect 2.0 app.

Security functions can be operated from optional wireless key fobs, Touchscreens, and Keypads.

Wireless sensors provide burglary protection and smoke and combustion detectors provide early fire and carbon monoxide (CO) warnings.

The system monitors sensors and system status to initiate alarms and generate alerts. It can also send alarm and status messages to a central monitoring station via the cellular phone network or the Internet. Additionally, the system can provide Two-Way Voice communication with the central station after a burglary alarm or emergency panic has been activated.

For the system to report alarms over the internet, your Wi-Fi network MUST remain powered at all times. You must arm the security system for it to sound burglar alarms.

Features

Fire Protection	Fire protection is always active when the system is operating normally and cannot be bypassed or suspended. An alarm sounds on all partitions if a fire condition is detected. See Fire / CO Alarm System for important information about fire protection, smoke detectors and planning emergency exit routes.
Carbon Monoxide	Carbon monoxide (CO) detectors, if installed, are always active and sound an alarm on all partitions if a carbon monoxide condition is detected. See Fire / CO Alarm System for more information.
Burglary Protection	The system provides HOME (STAY) and AWAY burglary protection. HOME mode protects windows and exterior doors, ignoring motion detectors, allowing you to move around inside your home without setting off an alarm. AWAY mode protects the entire premises, including interior motion detectors if present. Both modes offer an entry delay period that allows you to reenter the home without setting off an alarm. For long periods such as vacations, the entry delay can be turned off while arming the system. The system also allows you to Bypass selected sensors before arming the system. The system also features Chime mode, which can alert you to the opening of protected doors and windows while the system is disarmed.
Sensors	Each sensor, no matter what type, is to be programmed with a descriptor (Front Door, Kitchen Glass, Living Room Motion, etc.) by your Dealer. Anytime an alarm or an alert condition happens with any sensor, its descriptor is also displayed.
Panic buttons	Activate police and fire alarms or emergency alerts from the control, wireless keys or remote keypad. Panic modes can be customized by your Dealer.
Voice Commands	Use spoken trigger phrases to trigger system functions with Alexa. Requires setup with your Alexa account and applies to the PROA7PLUS only.

Getting to Know Your System (Continued)

Features (Continued)

Security Codes	At the time of installation, the Dealer asks the homeowner to choose a personal 4-digit security code, known as the "Master Code". Other users can be added, typically with less control over the system than the Master User. See User Codes section. A User Code is required when arming or disarming and for other functions. 4-digit codes allow the Control Panel to distinguish between users with different types of access privileges to system functions. The Master User is typically a household member who can perform all normal system functions. Guest and other users each have unique codes.
Alarms	Alarms are annunciated by the systems internal sounder (and external sirens if installed). The screen indicates the sensor from which the alarm has occurred. After 15 seconds, the sounder stops temporarily, and the system begins voice announcements of relevant sensor information. After the sensors are announced, the system's sounder resumes sounding. Alarm sounds, and voice announcements alternate until the system is disarmed or until alarm bell timeout occurs. If the system is connected to central monitoring, an alarm message is sent. To silence the sounder, disarm the system. The sensor causing the alarm to remain displayed, indicating Alarm Memory. Then Alarm Memory must be cleared by acknowledging, or disarming, it again.
Audio Alarm Verification (AAV) or Two-Way Voice	If enabled by your Dealer, your central monitoring station can listen in or talk hands free with persons on the premises through the Control Panel and Touchscreens only after a burglary alarm or an emergency panic has been activated. Two Way Voice sessions cannot be done for Fire or Carbon Monoxide alarms.
Automation	Automate lights, locks and other compatible Z-Wave and Z-Wave Plus™ devices. Many features can be remote controlled via the Total Connect 2.0 app.
Remote Services	Remote monitoring and control functions from mobile devices or web browser. Requires Total Connect 2.0 setup by your Dealer.
Built-in Camera	The Control Panel takes a snapshot of the person at the panel ONLY when they disarm the system from the main control panel. Snapshots can be viewed from the camera section in the system or via your Total Connect 2.0 account.

False Alarm Prevention

Many false alarms are caused by minor problems, such as a door left ajar when exiting the home. Your system includes several features to help prevent false alarms. Note that some are optional or must be programmed by the Dealer. Disabling these features may increase security but might also increase the chance of false alarms. Your Dealer can help you decide how to use and customize these features. A brief explanation of false alarm prevention features follows, along with advice on what to do if false alarms occur.

Entry / Exit Delays	Programmed delay times allow you to leave after arming the system or disarm it after entering without setting off an alarm. Exceeding a delay period causes an alarm. After a false alarm, disarm the system and contact your Central Station. They may verify your security code or password, preventing unnecessary calls for emergency response.
Entry Delay	If the system is armed, this is the period allowed between a door opening and the system being disarmed with a User Code. Failure to disarm the system during the Entry Delay causes an alarm. <i>Delay period set by your Dealer.</i>
Exit Delay	Period that begins upon arming the system, during which household members can exit through entry/exit doors without triggering an alarm. <i>Delay period set by your Dealer.</i>
Exit Alarms	False alarms can be caused by leaving the house and forgetting to close the door. If this happens, the system sounds an alarm and displays an Exit Error. The alarm reporting delay gives you time to disarm the system before a trouble message is sent.
Auto-Stay Arm	When arming in the AWAY mode and you do not exit the premises, (open and close the door), the system knows that you have not left and reverts to the HOME (STAY) mode at the end of the exit delay.
Quick Exit (Exit Time Restart)	If enabled, the system displays this option anytime it is armed Home, Home INSTANT, Night, or Night INSTANT. When selected, the exit delay starts. Use this feature as many times as needed while armed.
Exit Delay Reset	When armed AWAY and you leave the premises and enter again before the exit delay has expired, the exit delay resets, giving you more time to leave without causing an alarm. During the Exit Delay of being armed Away, select RESTART TIMER, which also restarts the exit delay. This feature can only be used one time during each arm AWAY period.
Silent Exit	Select "Silent Exit" to mute the beeping sound that accompanies exit countdowns when armed AWAY. Voice confirmation of arming status is not muted. Also, the exit time will be doubled if selected.
Alarm Reporting Delay	The system can be programmed to wait for a brief period between sounding a burglary alarm on the premises and sending an alarm message to your monitoring company. This delay allows you to disarm the system before an alarm message is sent in error.

The Home Screen

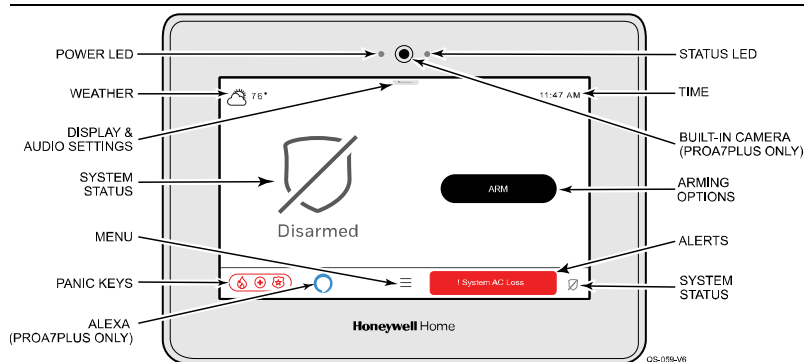

- Power and Status LED's above the screen.
- Built-In Camera takes Disarm pictures (PROA7PLUS).
- System status at the left and bottom-right.
- Arming options at the right of the screen.
- Weather status displays at top-left of screen.
- Time displays at top-right of the screen.
- Alerts: Displays any system or sensor troubles.
- Display & Audio Settings.
- Menu provides access to many system features.
- Panic Keys accessible from virtually any screen
- Alexa Voice Activated features (PROA7PLUS).

Status LED Indications

LED	Status	Meaning
AC Power (Left)	Green – Steady	AC Connected / Battery Charged
	Green – Flashing	Low Battery
	Off	No AC Power
Status (Right)	Green – Steady	System Ready to Arm
	Amber – Steady	System Trouble
	Red – Steady	System Armed
	Red – Flashing	Alarm or Alarm Memory or in Programming mode
	Off	Not Ready to Arm
	Green – Flashing	Device trouble – System can be Armed
	Amber – Flashing	Device trouble – System cannot be Armed

NOTE: If the control loses AC power, the status LED begins to blink slowly after 15 minutes on battery backup (red if the system is armed, green if it is disarmed).

Arming Modes and Status Displays

Details on arming modes and status displays are explained in the next sections.

Selection	Function
Disarmed, Not Ready	Indicates the system is Disarmed and sensors are faulted. Sensors can either be closed or bypassed before arming.
Disarmed, Ready	Indicates the system is Disarmed and is Ready to Arm.
Arm Away	Indicates the system is armed in Away mode. (No one is inside the premises)
Arm Home	Indicates the system is armed in Home (Stay) mode. (Someone is inside the premises)
Arm Night	Indicates the system is armed in Night mode. (Someone is inside the premises during the night and only certain motion detectors are armed)
RESTART TIMER	Displayed during Exit Delay. Select to restart the exit delay as many times as needed.
CANCEL	Displayed during Exit Delay. Select to cancel Arming session.

Selection	Function
Weather	Displayed in top-left and gives access to the 5-day forecast.
Display & Audio Settings	Accesses settings for Voice, Chime, Brightness, Volume and more.
11:47 AM Time	Time displayed in top-right and updated automatically.
Panic Keys	Access to programmed Panic Keys such as Fire, Police, Medical.
Amazon Alexa	Indicates Alexa has been enabled by your Dealer and has been setup on a device. (PROA7PLUS)
Alerts	Alerts are displayed for any potential trouble condition with the system or with a sensor.
Menu	The Menu allows access to many unique features of the system. See next page.

Getting to Know Your System (Continued)





Menu





The Menu gains access to many system features pictured below. Some provide a list of selectable options while others direct you to a different screen. Scroll down in the Menu to see all features. Details on each of the features are explained throughout this manual. Selecting  (Menu) displays the following features.



Menu Features

Below are brief descriptions of the features that are found in the Menu.

Selection	Function
 Favorites	Provides quick access to user selected Z-Wave Automation devices.
 Devices	Provides access to Z-Wave <i>Devices</i> and Z-Wave <i>Management</i>
 Sensors	Provides access to sensor information and options
 Cameras	Provides access to stored camera clips (PROA7PLUS Only).

Selection	Function
 Scenes	Provides access to <i>Scenes</i> for Z-Wave Automation
 Events	Provides access to system <i>Activity Log</i> .
 Settings	Provides access to <i>Wi-Fi settings</i> , <i>User Management</i> , and <i>Voice Services (Amazon Alexa)</i>
 Tools	Provides access to System Info (Version and ID's), <i>System Tests</i> (Communicator and Sensors), and System Reboot

Understanding Your Sensors







There are numerous types of sensors that can be part of the Security System:

- | | | | | |
|-----------|-----------------------|-------------------|----------------------------|---------------|
| • Doors | • Motion | • Smoke / Heat | • Medical / Panic Pendants | • Water |
| • Windows | • Glass Break / Shock | • Carbon Monoxide | • Key Fob Remote | • Temperature |

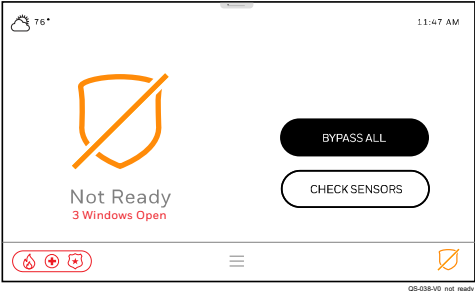
The programming done by your Dealer for each type of sensor determines how the system reacts to them. All sensors send a fault (open) signal when activated with a respective restore (close) signal when it becomes normal again. **Example:** When a door or window is opened, the sensor sends a fault signal and displayed as open along with an audible Chime sound (if programmed). When the door is closed a restore signal is sent to clear the fault from the display. The system must be Armed before the door, window, motion, and glass break sensors go into alarm. Other sensors such as water, and temperature can be programmed to react as an alarm or just a notification if desired. Fire, Carbon Monoxide sensors, Panics and Medical pendants / buttons are 24-hour, and go into alarm when activated if the system is armed or disarmed.

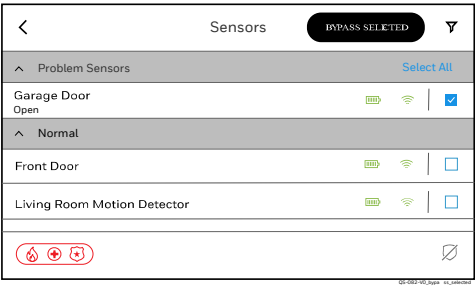
NOTES:

- Wireless motion detectors utilize a 3-minute timeout to conserve battery life. This means when you walk through their coverage area, they send a fault signal to the system, then, send a restore signal immediately thereafter to clear the fault. After sending the restore signal, they go to “sleep” for 3 minutes and do not detect motion. After 3 minutes, returns to its active state and waits to detect motion again and repeats the process.
- Your PROA7/PROA7PLUS system supervises all sensors except for certain panic buttons and Key Fobs, which are transmitters that can be taken off premises. If the system does not receive the supervision signals from each sensor, that sensor causes an Alert, even if the system is armed in any mode.
- Most sensors have cover and / or wall tampers that, when opened, causes an Alert while disarmed and an alarm while armed.

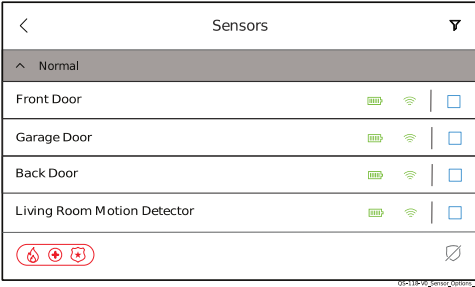
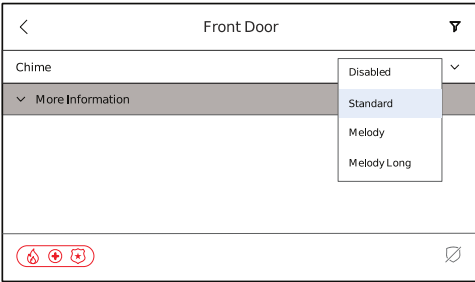
Touchscreen Display	Description												
	<p>When any sensors are faulted, the system displays a orange shield along with at least one of the faulted sensors. To view all faulted sensors, select . Bypassing sensors is covered later.</p>												
	<p>A list of all sensors is displayed, which also indicates any sensors that are faulted. The “Normal” sensors are sensors that are not faulted. Select  to filter the view of the sensors by Status, Name or Device Type. This example displays by “Status”. The same list of sensors can be accessed by selecting  from the Home screen, then, select “Sensors” .</p>												
	<p>Chime sounds can be changed, and important information can be viewed for each sensor. When Chime is enabled, each door and window sensor sound the Chime on the Control Panel and Touchscreens when they are faulted. Sensors are defaulted to the “Standard” Chime sound, which is 3 beeps. Motion sensors are not typically enabled to Chime. Different sounds can be selected for different sensors if desired. No matter what Chime sound is selected, it is followed by the voice annunciation of the descriptor, i.e. “Front Door”, known as Voice Chime. Select each sensor, one at a time by touching anywhere in the name box.</p>												
	<p>Select the drop-down arrow and a list of available Chime sounds is displayed. Scroll down to see all options:</p> <table border="0"> <tr> <td>• Disabled</td> <td>• Ascend</td> <td>• Doorbell 1</td> </tr> <tr> <td>• Standard</td> <td>• Ascend Long</td> <td>• Doorbell 2</td> </tr> <tr> <td>• Melody</td> <td>• Alert 1</td> <td>• Evolve</td> </tr> <tr> <td>• Melody Long</td> <td>• Alert 2</td> <td></td> </tr> </table>	• Disabled	• Ascend	• Doorbell 1	• Standard	• Ascend Long	• Doorbell 2	• Melody	• Alert 1	• Evolve	• Melody Long	• Alert 2	
• Disabled	• Ascend	• Doorbell 1											
• Standard	• Ascend Long	• Doorbell 2											
• Melody	• Alert 1	• Evolve											
• Melody Long	• Alert 2												
<p>IMPORTANT</p> <p>The Chime feature is intended for convenience and is not intended for life safety purposes or pool alarm and does not meet the requirements of UL2017.</p>													





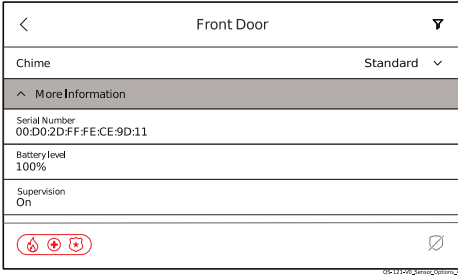
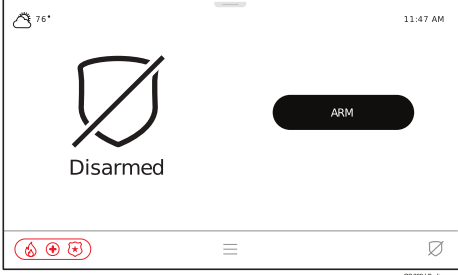

Operating the Security System (Continued)

Understanding Your Sensors (Continued)

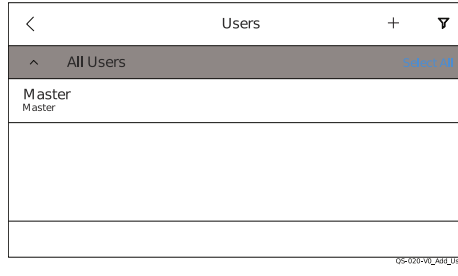
Touchscreen Display	Description
	Review “More Information” for important details about each sensor. Scroll down to see all information.
	When all sensors are closed and there is no activity, no faults are displayed, and the system reflects a simple “Disarmed” state. This means the system is “Ready to Arm”.

Adding User Codes

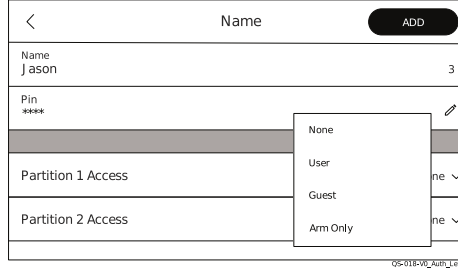
The PROA7/PROA7PLUS security system supports up to 96 different 4-digit User Codes to arm, disarm, and restrict certain functions to selected users. 4-digit codes cannot be duplicated, and the system must be disarmed before any codes can be programmed. User Codes can be used interchangeably when performing system functions (can arm with one code and disarm with another) as long as the authority level allows it. **NOTE:** Do not use easily guessable User Code like 0000, 1111, 4444, 1234, 4321, etc. User should choose a User Code where the number are not repeating or not adjacent.

Touchscreen Display	Description
	<ol style="list-style-type: none">1. Select .2. Scroll down and select “Settings” .3. From the right, select “User Management”.4. Enter the Master or Partition Master code on the displayed keypad. The default Master code is 1234. It displays the existing Master user which can be changed at any time.5. To add a new user, select “+”.6. Enter the name of the person for the new user in the displayed keyboard.7. Select .
	<ol style="list-style-type: none">8. The new user’s name is displayed.9. Select the “pencil” icon on the right side of the “Pin” box to enter the user’s new 4-digit code.10. Enter the new 4-digit code for the new user in the displayed keypad. The system displays asterisks for each digit of the user’s 4-digit code. Select the down arrow on the right side of each of the desired “Partition Access” box to display a list of Authority Levels.11. Select the appropriate Authority Level for this user. Scroll down to see all options.12. Once complete, select .

Authority Levels:

- **None** – User does not work in the partition.
- **User** – User can arm, disarm, and bypass sensors in the partition. This is used for typical users who are household members and other authorized persons who can arm and disarm the security system and has limited access to other system features.
- **Guest** – User can disarm only if it was used to arm. For visitors and others who you authorize to arm and disarm the system on a temporary basis.
- **Arm Only** – User can arm only and cannot disarm. Use this for visitors and others who you authorize to ONLY arm the system.
- **Master** – The Master code has authority to add, change, or delete any User Code and assign any authority level to any user in any partition in the system. Used for the owner of the premises.
- **Partition Master** – Same as Master code but cannot change the Master code.
- **Duress** – Will send a Duress signal to the Central Monitoring center when used to disarm the system. This is used in case someone is being held up while at home and forced to disarm the system.

Adding User Codes (Continued)

Touchscreen Display	Description
	<p>13. Enter the Master or Partition Master code in the displayed keypad to add the new user in the system.</p> <p>The new user's information is displayed.</p> <p>NOTE: Limited-access users such as babysitters, guests, and cleaning staff should not be instructed on system functions other than those they are using.</p> <p>Once the user has been added, you can edit the user and enable Bluetooth Options (Bluetooth disarm explained later in the Automation section) and Z-Wave lock controls. If using Z-Wave door locks, you can Synchronize user codes with the control panel by selecting "Sync user code to lock".</p>

Arming Your Single Partition System

Arm your system when all sensors are closed (Ready to Arm) or when sensors are faulted (Not Ready to Arm) which requires them to be bypassed, if you cannot close the sensors, typically doors or windows. When a sensor is bypassed, the system ignores that sensor until it is unbypassed. Once all faulted sensors are bypassed, the system becomes Ready to Arm. There are a couple of options when it comes to bypassing sensors.

Arming while "Ready to Arm"

Touchscreen Display	Description
	<p>1. The display shows that the system is Disarmed and Ready to Arm, which means all sensors are closed. Select ARM to choose your arming mode.</p> <p>NOTE: The status LED above the screen lights green when the system is ready to be armed. If it not displayed, there are faulted sensors and the system is "Not Ready to Arm".</p>



Arming while "Not Ready to Arm", Force Bypassing Sensors

	<p>1A. If the "Force Bypass" feature is enabled by your Dealer, then selecting BYPASS & ARM automatically bypasses all faulted sensors and you can choose your arming mode.</p> <p style="text-align: center;">- OR -</p> <p>1B. If the "Force Bypass" feature is disabled, select BYPASS ALL.</p> <p>Enter a valid 4-digit code in the displayed keypad. This bypasses all faulted sensors</p>
	<p>2. Once all faulted sensors are bypassed, the option to arm the system is displayed. Select ARM to choose your arming mode. See "Choosing your Arming Mode" Later in this section.</p>

Operating the Security System (Continued)

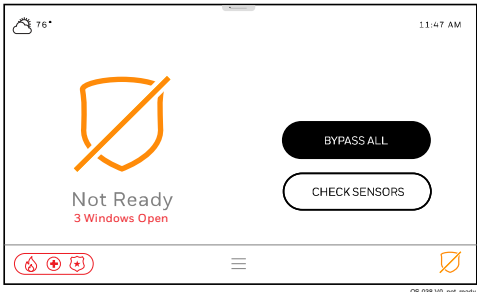
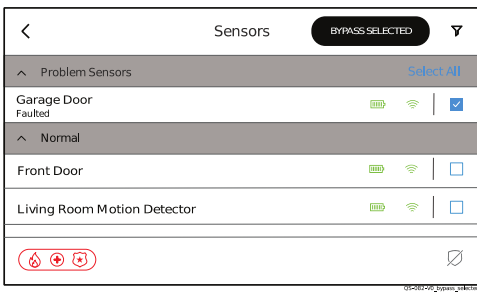

Arming Your Single Partition System (Continued)

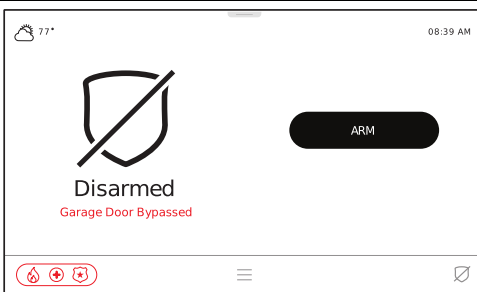
Arming while “Not Ready to Arm”, Manually Bypassing Sensors

Touchscreen Display	Description
	<p>1. Select CHECK SENSORS to display a list of all sensors which indicates faulted sensors that can be bypassed.</p>
	<p>2. Individual sensors can be selected to be bypassed by touching the checkbox on the far-right side of each sensor whether they are faulted or normal, or “Select All” selects all the faulted sensors.</p> <p>3. Select BYPASS SELECTED.</p> <p>4. Enter a valid 4-digit code in the displayed keypad.</p> <p>5. This screen displays all the sensors that have been bypassed. Touch the back “<” icon.</p>
<p> Fire, Heat, and Carbon Monoxide sensors CANNOT be bypassed!</p>	
	<p>6. Once all faulted sensors are bypassed, the option to arm the system is displayed. Select ARM to choose your arming mode.</p>

Arming Your Single Partition System (Continued)

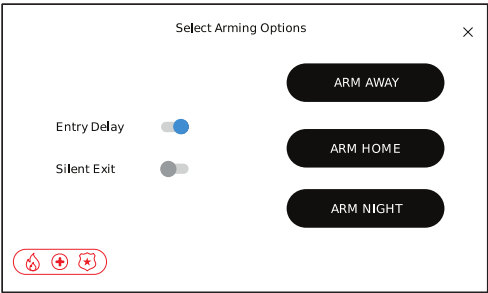
Choose Your Arming Mode

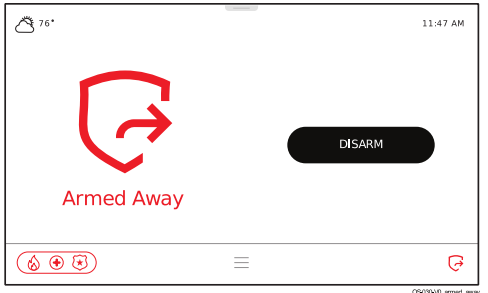
Touchscreen Display	Description
	<p>1. Choose your arming mode:</p> <ul style="list-style-type: none"> ARM AWAY – You are leaving and are away from the premises. All doors, windows, and motion detectors are armed. ARM HOME – You are staying inside the premises. The doors and windows are armed, but all motion detectors are ignored by the system, so you can walk past any motion detector without causing an alarm. The system can also be armed in this mode while motion detectors are faulted. ARM NIGHT – If enabled by your Dealer, you are staying inside the premises during the night while certain, select motion detectors are armed (i.e. downstairs or garage motion detectors). Discuss with your Dealer which detectors are going to be armed, if desired. All other motion detectors are still ignored. The Entry Delay can also be enabled / disabled. Blue indicates it is enabled. If disabled, this arms any mode in INSTANT mode; HOME INSTANT, AWAY INSTANT or NIGHT INSTANT. INSTANT prevents the Entry Delay from occurring when the Entry / Exit door is faulted after the exit delay has expired, resulting in an “instant” alarm. Exit beeps can be enabled / disabled by toggling “Silent Exit”. This only applies to arming AWAY. Arming HOME or NIGHT does not provide any exit beeps during the exit delay. <p>NOTES:</p> <ul style="list-style-type: none"> There is always an exit delay, no matter what mode the system is armed in and cannot be changed. When arming AWAY and Silent Exit is disabled, the last 10 second of the exit delay beeps rapidly to indicate the delay is almost over.
	<p>2. Enter a valid 4-digit User Code in the displayed keypad.</p> <p>NOTES:</p> <ul style="list-style-type: none"> If the “Quick Arm” feature has been enabled by your Dealer, the keypad does not display. Instead, the system arms as soon as you select an arming mode from the above screen, then display the countdown on the next screen. The system’s Activity Log lists the arming event as a “Quick Arm” instead of logging it with a user’s name. It logs the user’s name when the user’s 4-digit code is entered for arming and disarming, when a Key Fob is used, or from Total Connect per the User’s login affiliated with their code. <p>3. The system reflects the arming mode and the time remaining in the Exit Delay countdown.</p> <p>To “CANCEL” the arming, select the “CANCEL” icon and a keypad is displayed. Type in your 4-digit code to disarm it. “RESTART TIMER” allows you more time to exit if needed during the Exit Delay. This can also be restarted by opening, closing, then re-opening the door during the delay as well (If you get to the car and forget your car keys in the house). Either way, this works only one time for each armed AWAY period and the “RESTART TIMER” option disappears once it has been restarted.</p>
	<p>4. Once the countdown is complete, it displays the current armed status with the option to DISARM.</p> <p>NOTES:</p> <ul style="list-style-type: none"> If the “Auto-Stay” feature is programmed by your Dealer and you arm AWAY without opening and closing the Entry Exit door, the system assumes you did not exit the premises and automatically reverts to the HOME (STAY) mode after the exit delay expires. If you accidentally leave the door open after leaving and the exit delay expires, the “Exit Error” feature is activated, a keypad is displayed, and an “Exit Error” signal is sent to the central station. This is a trouble signal, not an alarm. This means there was an error upon exiting the system. The Entry Delay timer starts along with a solid tone warning you to disarm or an alarm occurs. If it is not disarmed, the system sends an alarm signal to the Central Station. This also happens if there is a motion sensor faulted at the end of the Exit Delay.

Operating the Security System (Continued)

Disarming Your Single Partition System

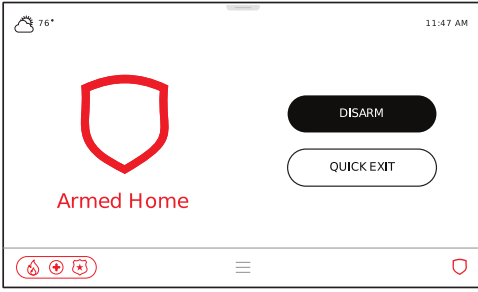
Touchscreen Display	Description
	<ol style="list-style-type: none">1. If the system is armed Home, Home INSTANT, Night, or Night INSTANT and you are still in the premise, simply select DISARM. <p>NOTE: If the “Quick Exit” feature has been enabled by your Dealer, the system displays this option anytime it is armed Home, Home INSTANT, Night, or Night INSTANT. When selected, the exit delay starts. This is in case you need to leave the premises with someone staying inside or you need to let your pets outside without having to disarm and re-arm the system. Use this feature as many times as needed while armed.</p> <ol style="list-style-type: none">2. The Keypad is displayed after selecting DISARM or after opening an Entry / Exit door when armed in any mode, except for an INSTANT mode. After opening the door, the system starts the entry delay beeps, giving you time to disarm.3. Type in your 4-digit User Code. Once disarmed, the system displays its status. <p>NOTE: Any bypassed sensor is automatically unbypassed when the system is disarmed.</p>

Unbypassing Sensors

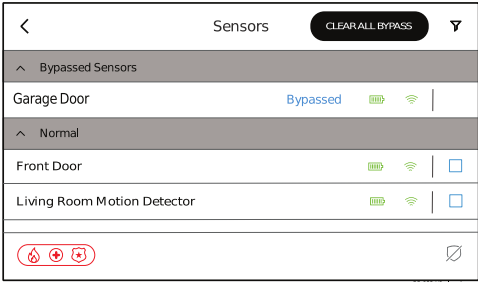
Touchscreen Display	Description
	<p>All bypassed sensors can be unbypassed either manually through this screen, or they unbypass automatically when the system is disarmed from any armed state or when a disarm command (4-digit code plus 1 OFF) is entered on a Keypad.</p> <ol style="list-style-type: none">1. Select ☰.2. Select “Sensors” (●).3. This screen displays all sensors, including the sensors that are bypassed.4. To clear any bypassed sensor, select CLEAR ALL BYPASS.5. Enter a valid 4-digit code in the displayed keypad.

Display & Audio Settings

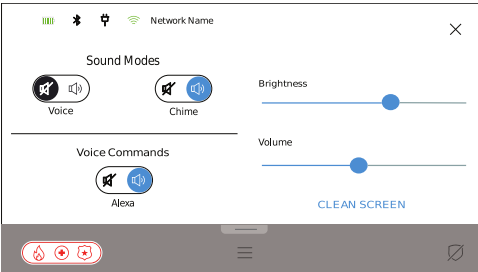
Touchscreen Display	Description
	<p>Select and drag down the Display & Audio Settings tab ☰ from the top of the screen. Voice status and Chime sounds can be enabled / disabled here. Blue indicates it is enabled. Screen brightness and volume can also be adjusted. Volume adjustment affects only Voice, Chime sounds, and Alerts. Alarm sounds are fixed and cannot be adjusted.</p> <p>The system provides 2 types of voice feedback:</p> <ul style="list-style-type: none">• Voice Status - Annunciates armed, disarmed, trouble and alarm status.• Voice Chime - Annunciates faulted sensors: “Front Door”, “Kitchen Window”, etc. <p>If “Chime” is disabled, the system no longer provides any selected Chime sounds nor Voice Chime when a sensor is faulted.</p> <p>If “Voice” is disabled, the system no longer annunciates Voice Status nor Voice Chime, however the Chime sounds are still announced if “Chime” is enabled. Chime is only provided for door and window sensors.</p>

Arming Your Multi-Partitioned System

Up to 4 partitions can be enabled in the security system by your Dealer. Partitioning allows a system to be divided into separate parts which are controlled independently from each other. Some examples of partitions would be the garage, out building, pool house, storage room, or even the basement, however, it is not necessary. These would be personal preferences that you can talk to your Dealer about. The Control Panel is generally partition 1 while any Touchscreen or Keypad can be assigned to any active partition. Any partition can be accessed from the Control Panel, Touchscreens, or Keypads to control that partition.

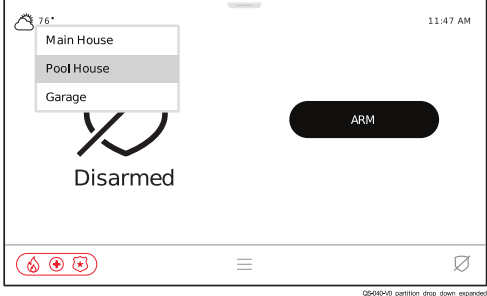

IMPORTANT: If partitions are enabled, Fire and CO Alarms are displayed and sounds on other partitions' Touchscreens / Keypads. The alarms can be silenced from each partitioned keypad, but alarm memory can only be cleared from the partition's Touchscreen / Keypad in which the alarm occurred.

Touchscreen Display	Description
	<ol style="list-style-type: none">1. Once more than one partition is enabled in your system, the Control Panel and Touchscreens display its partition name with a drop-down arrow. Touch the partition name and a drop-down menu is displayed with all active partitions.2. Select the partition that you want to log onto.3. Enter a valid 4-digit code to change partitions. It then displays the status of that partition which allows you to control it the same way as previously described for a single partition systems. <p>NOTES:</p> <ul style="list-style-type: none">• The User Code MUST be programmed into all active partitions before it can be used to log onto another partition.• The Touchscreens automatically change back to its home partition after 2 minutes of no activity; Keypads (PROSiXLCDKP) change back to its home partition after 30 seconds.

In Case of an Alarm

If any alarm occurs, your Central Monitoring Station may call you before or after dispatching the proper authorities.

There are 3 different types of alarms:

1. Fire
2. Carbon Monoxide (CO)
3. Intrusion (Burglary) / Police and Medical Panic

Fire – If smoke or heat sensors are installed by your Dealer, they are active 24 hours a day, providing continuous protection. In the event of a fire, the installed smoke or heat sensors automatically activate the security system, triggering a loud, “Temporal 3 Pulse” (3 beeps, pause, 3 beeps, pause, etc.) sound at the Control Panel, Touchscreens, Keypads, Sirens and all SiX™ Series smoke, carbon, and heat detectors. The Control Panel's and Touchscreen's sounds alternate with the voice announcement. A “FIRE” message appears on the Control Panel, Touchscreens, and Keypads, and remains until you silence the alarm and clear the display.

In case of a Fire:

1. Should you become aware of a fire emergency before your smoke and heat sensors detect it, go to the Control Panel, any Touchscreen or Keypad and select the Panic icon (🔥🚒🚑), then select the Fire 🔥 icon. The alarm sounds as described above, and a fire alarm signal is transmitted to the central station.
2. Evacuate all occupants from the premises.
3. If smoke and / or flames are present, leave the premises and call your local authorities immediately.
4. If no flames or smoke are apparent, you may investigate the cause of the alarm.

Carbon Monoxide - If CO sensors are installed by your Dealer, they are active 24 hours a day, providing continuous protection. In the event of a CO leak, the installed Carbon Monoxide sensors automatically activate the security system, triggering a loud, “Temporal 4 Pulse” (4 beeps, pause, 4 beeps, pause, etc.) sound at the Control Panel, Touchscreens, Keypads, Sirens and all SiX™ Series smoke, carbon, and heat detectors. The Control Panel's and Touchscreen's sounds alternate with the voice announcement. A “CO” message appears on the Control Panel, Touchscreens, and Keypads, and remains until you silence the alarm and clear the display.

In case of a CO alarm:

1. If a high level of carbon monoxide is detected you should evacuate all occupants from the premises immediately and move to a location where fresh air is available, preferably outdoors.
2. From a safe area, contact your local authorities.





IMPORTANT! For the safety of persons on the premises, Fire and Carbon Monoxide alarms CANNOT be silenced or cleared remotely with Total Connect 2.0. Alarms of this type can ONLY be silenced and cleared from the Control Panel, Touchscreens, or Keypads.

Operating the Security System (Continued)

Intrusion – Door, window, shock, glass break, and motion sensors are active only when the system is armed. In the event of an intrusion, the installed sensors activate the security system, triggering a loud, steady tone at the Control Panel, Touchscreens, Keypads, and Sirens. The Control Panel's and Touchscreen's sounds alternate with the voice announcement. An "Intrusion Alarm" message appears on the Control Panel, Touchscreens, and Keypads, and remains until you silence the alarm by entering your 4-digit code. This is also known as acknowledging the alarm.

In case of an Intrusion:

1. Should you become aware of a burglary before the security sensors detect it, go to the Control Panel, any Touchscreen or Keypad and select the Panic  icon, then select the Police  icon. The alarm sounds as described above, if programmed, otherwise it can be silent (if programmed so), and a Panic alarm signal is transmitted to the central station. Get to a safe location and contact your local authorities immediately.
2. If the System is sounding for a burglar alarm when you come home, an alarm has already occurred, and an intruder may still be nearby. Leave immediately and contact your local authorities.

Two-Way Voice / Audio Alarm Verification (AAV)

If this feature has been enabled by your Dealer, it allows your central monitoring station to listen-in and / or talk with persons on the premises, hands free, through the Control Panel and up to 4 Touchscreens, ONLY after a burglar or panic alarm has been activated. This is called a "voice session". They can listen in to determine if there is a hostage situation taking place without the intruder knowing that they're listening, and / or they can talk to persons on the premises in case they are unable to move. All alarm sounds are muted during the voice session so that clear voice communications can take place. Once the session is terminated by the central station, alarm sounds restart and keep sounding until the alarm is acknowledged or until the alarm sounder timeout has occurred. A voice session cannot take place again until the central station receives a new burglar or panic alarm.

NOTES:

- 2-Way Voice / AAV sessions takes place over Cellular communication.
- Newly activated Fire and CO alarms terminates a voice session and report the alarm immediately.
- Fire and CO alarms do not allow 2-Way Voice / AAV sessions to take place. Instead, all persons should evacuate the premises.
- Additional burglar alarms occurring during voice session do not interrupt the session. They are reported immediately after the central station terminates the voice session.
- Two-Way Voice / AAV modes are controlled by the central station.

In Case of an Alarm (Continued)

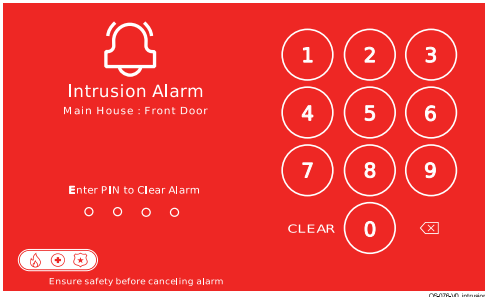
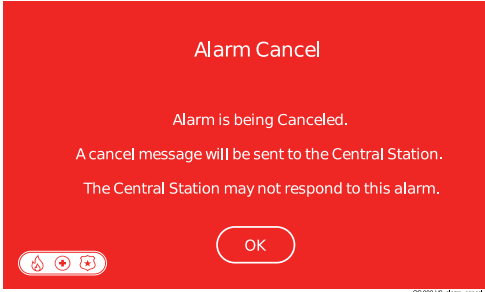
Touchscreen Display	Description
	<p>1. Intrusion alarms are accompanied by a solid tone from the Control Panel, Touchscreens, Keypads, and Sirens. It displays the partition name (if partitions are enabled) and the first sensor that activated the alarm along with a Keypad to enter a valid code to disarm and acknowledge the alarm. Once a code is entered, all alarm sounds are silenced. To view any additional sensors that went into alarm, see the system's Activity Log.</p> <p>NOTE: If an "Alarm Reporting Delay" has been enabled by your Dealer, and you enter your 4-digit code before this delay time expires, no intrusion signals are sent to your Central Station! If the delay expires before a code is entered, the intrusion signal is sent. This delay does NOT affect Fire, CO, or Panics! These are sent immediately!</p>
	<p>2. "Cancel" reporting is always enabled, It displays this "Alarm Cancel" message. Select "OK" to clear the Alarm Memory and the system returns to normal.</p>

Operating the Security System (Continued)

Panic Alarms

Touchscreen Display	Description
	1. Select  to advance to the Emergency screen. This panic icon is selectable from most screens.
	2. Select Fire, Police, Medical, or Silent Alarm for activation. To exit this screen without activating any panics, select "X". Depending on how these panics are programmed by your Dealer determines what is displayed on this screen and how they operate. NOTE: The Police panic can be programmed to be either audible or silent. Audible means that all Touchscreens, Keypads, and Sirens initiates alarm sounds. Silent means that there are no alarm sounds, nor any indication on the Control Panel, Touchscreens, or Keypads that any alarm is happening.
	3. The screen displays the initiated Panic alarm. Select  .
	4. Enter a valid 4-digit code in the displayed keypad to acknowledge the alarm and silence the alarm sounds.
	5. It displays this "Alarm Cancel" message. Select "OK" to clear the Alarm Memory and the system returns to normal.

Alerts

Alerts are potential system and sensor trouble conditions that are displayed in the lower right corner of the Control Panel and Touchscreens and are accompanied by beeping. They continue to beep until you acknowledge it. Contact your Dealer if the system displays any of the following Alerts:

- System AC Loss
- RF Jam
- Panel Tamper
- Loss of Communications
- System Low Battery
- Sensor Low Battery
- Sensor Trouble (Transmitter Tamper, Loss of Supervision)

The following explains how to treat a common trouble condition with a door / window sensor if its cover is removed (Tampered). Removing a cover from any sensor cause that sensor to go into a trouble condition and must be acknowledged to stop the beeping.

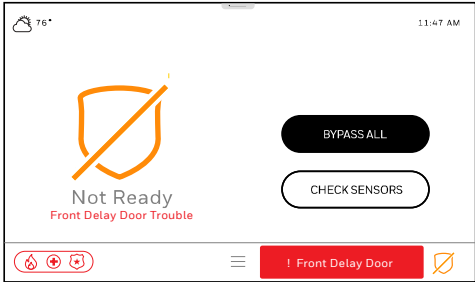
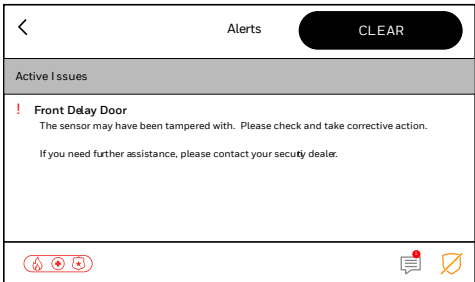
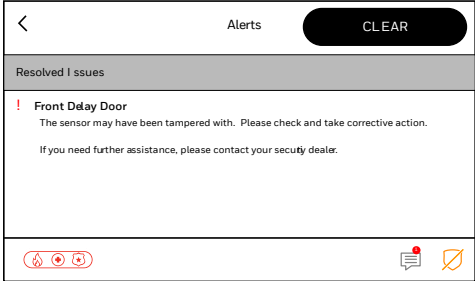
Touchscreen Display	Description
 <p>The screenshot shows the main security system interface. At the top, it displays the temperature (76°) and time (11:47 AM). The central area features a large orange shield icon with a diagonal slash and the text 'Not Ready' and 'Front Delay Door Trouble'. Below this are two buttons: 'BYPASS ALL' and 'CHECK SENSORS'. At the bottom, there is a red bar with a white exclamation mark and the text 'Front Delay Door', and a small icon of a door with a slash.</p>	<p>1. To acknowledge any Alert, simply touch the red box at the bottom of the screen and any existing beeping stops.</p>
 <p>The screenshot shows the 'Alerts' screen. At the top, there is a 'CLEAR' button. Below it, under the heading 'Active Issues', there is a red exclamation mark icon and the text 'Front Delay Door'. The message reads: 'The sensor may have been tampered with. Please check and take corrective action. If you need further assistance, please contact your security dealer.' At the bottom right, there is a small icon of a door with a slash.</p>	<p>2. If the condition still exists after acknowledging it, it is listed as an "Active Issue" and remains on the display as a bubble at the bottom-right indicating how many Alerts are still active.</p>
 <p>The screenshot shows the 'Alerts' screen. At the top, there is a 'CLEAR' button. Below it, under the heading 'Resolved Issues', there is a red exclamation mark icon and the text 'Front Delay Door'. The message reads: 'The sensor may have been tampered with. Please check and take corrective action. If you need further assistance, please contact your security dealer.' At the bottom right, there is a small icon of a door with a slash.</p>	<p>3. Put the cover back on the sensor and make sure the door / window is closed. This causes the sensor to send a "tamper restore" signal to the system and is then listed as a "Resolved Issue".</p> <p>4. Select CLEAR RESOLVED ISSUES to clear the memory from the system.</p> <p>5. Enter a valid 4-digit code in the displayed keypad.</p>



NOTE: For door and window sensors, before the tamper trouble can be cleared from memory, the cover must be on AND the door / window must be physically closed. If the cover is on, but the door / window is still open, the Alert does not clear from memory.

Operating the Security System (Continued)

Activity Log

Your system logs up to 4,000 events. Once the Activity Log is full, the oldest events are removed as newer events are logged. Each event that is logged has a respective “restore” that is logged as well. There are different types of events that are logged by your system:

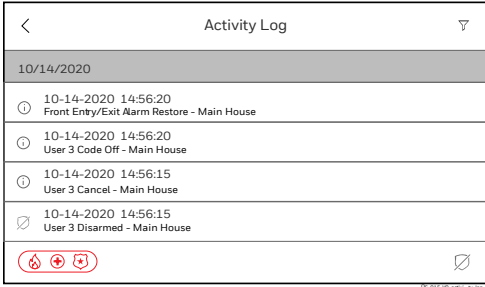
- Alarms
- Alerts (Troubles)
- Arm / Disarm -Displays User Names
- Sensor Bypasses
- Automation Events

Touchscreen Display	Description
	<ol style="list-style-type: none"> 1. Select . 2. Scroll down and select “Events” . 3. Enter a valid 4-digit code in the displayed keypad. 4. All events are listed in the order in which they occurred. Scroll down to continue viewing. The latest event is displayed first and is indicated as “Log Index: 0”.

Activity Log Events

Event	Activity Log Display
Medical Alarm / Medical Alarm Restore	Medical Alarm / Medical Alarm Restore
Fire Alarm / Fire Alarm Restore	Fire Alarm / Fire Alarm Restore
Smoke Alarm / Smoke Alarm Restore	Smoke Alarm / Smoke Alarm Restore
Panic Alarm / Panic Alarm Restore	Panic Alarm / Panic Alarm Restore
Duress Alarm / Duress Alarm Restore	Duress Alarm / Duress Alarm Restore
Silent Alarm / Silent Alarm Restore	Silent Alarm / Silent Alarm Restore
Audible Alarm / Audible Alarm Restore	Audible Alarm / Audible Alarm Restore
Perimeter Alarm / Perimeter Alarm Restore	Perimeter Alarm / Perimeter Alarm Restore
Interior Alarm / Interior Alarm Restore	Interior Alarm / Interior Alarm Restore
Day / Night Alarm; Day / Night Alarm Restore	Day / Night Alarm; Day / Night Alarm Restore
Sensor Tamper Alarm	Tamper Alarm / Tamper Alarm Restore
Base Unit & Keypad Failure / Base Unit & Keypad Restore	Exp Module Failure / Exp Module Restore
Base Unit & Keypad Tamper / Base Unit & Keypad Restore	Exp Module Tamper / Exp Tamper Restore
Silent Burglary Alarm/Silent Burglary Alarm Restore	Silent Burglary / Silent Burglary Restore
24-Hour Non-Burglary Alarm / 24-Hour Non-Burglary Alarm Restore	24 Hr Non-Burglary Alarm / 24 Hr Non-Burglary Alarm Restore
Carbon Monoxide Alarm	CO Alarm
AC Power Loss / Trouble AC Power Restored	AC Loss / AC Restore
System Low Battery Trouble / System Low Battery Restore	System Low Battery / System Low Batt Restore
System Reset Trouble / System Reset	System Reset
System shutdown / System Resume	System shutdown / System Resume
Battery Test Failure / Battery Test Passed	Battery Test Fail / Battery Test Pass
Battery Discharged or Not Installed / Battery Installed	Battery Dead / Missing / Battery Installed
System Tamper / System Tamper Restore	System Tamper / System Tamper Restore
System Peripheral Trouble / System Peripheral Trouble Restore	System Peripheral Trouble / System Periph. Trouble Restore
Expansion Module Failure / Expansion Module Restore	Exp Module Failure / Exp Module Restore
Expansion Module Battery Failure / Expansion Module Battery Restore	Exp Module Batt. Failure / Exp Module Batt. Restore
Base Unit & Keypad Tamper Trouble / Restore	Cover Tamper / Cover Tamper Restore
RF Jam Detected / RF Jam Restore	RF Jam Detect / RF Jam Restore
Communication Path Trouble / Communication Path Restore	Comm. Path Trouble / Comm Path Restore



Operating the Security System (Continued)

Activity Log Events (Continued)

Event	Activity Log Display
Cellular Communication Transmitter Trouble / Cellular Communication Restore	Cellular Comm. Trouble / Cellular Comm. Restore
Failure to Communicate Event / Communications Restored	Fail to Communicate / Comm. Restore
Sensor Faulted / Sensor Restored	Sensor Faulted / Sensor Fault Restored
Fire Trouble / Fire Trouble Restore	Fire Trouble / Fire Trouble Restore
Exit Error Alarm / Exit Error Restore	Exit Error Alarm / Exit Error Restore
Cross Sensor Trouble / Cross Sensor Trouble Restore	Cross Sensor Trouble / Cross Sensor Trouble Restore
Sensor Trouble / Sensor Trouble Restore	Sensor Trouble / Sensor Trouble Restore
Loss of RF Supervision Trouble / RF Supervision Restore	Superv Loss-RF / Superv Restore-RF
Sensor Tamper Trouble / Sensor Tamper Restore	Sensor Tamper / Sensor Tamper Restore
RF Low Battery / RF Low Battery Restore	RF Low Battery / RF Low Battery Restore
Smoke Detector High Sensitivity Trouble / Smoke Detector High Sensitivity Restore	High Sense / High Sense Restore
Smoke Detector Low Sensitivity Trouble / Smoke Detector Low Sensitivity Restore	Low Sense / Low Sense Restore
Carbon Monoxide End of Life / Carbon Monoxide End of Life Restore	Carbon Monox End of Life / Carbon Monox End of Life Restore
System Armed Away / System Disarmed	Arm Away / Disarmed
Cancel	Cancel
System Armed Remotely / System Disarmed Remotely	Armed Remotely / Disarmed Remotely
Quick Arm (Arm without a User Code)	Quick Arm
Download Okay	Download OK
Security Off	Security Off
System Armed Stay / System Disarmed	Arm Stay / Disarmed
Exit Error (Error Upon Exiting the System)	Exit Error
Recent Close (Alarm Within 5 Minutes of Arming)	Recent Closing
Wrong Code Entry	Wrong Code Entry
Sensor Bypass / Sensor Bypass Restore	Sensor Bypass / Sensor Bypass Restore
Fire Bypass / Fire Bypass Restore	Fire Bypass / Fire Bypass Restore
Burglary Sensor Bypass / Burglary Sensor Bypass Restored	Burg Bypass / Burg Bypass Restore
Manual Trigger Test Start / Manual Trigger Test End	Man Trigger Test Start / Man Trigger Test End
Periodic Test Report	Periodic Test Rep
Walk Test Mode Start / Walk Test Mode End	Walk Test Start / Walk Test End
Event Log 90% Full	Event Log 90% Full
Program Mode Entry	Program Mode Entry
Program Mode Exit	Program Mode Exit
System Inactivity	System Inactivity
Reset Master Code	Reset Master Code

Operating the Security System (Continued)

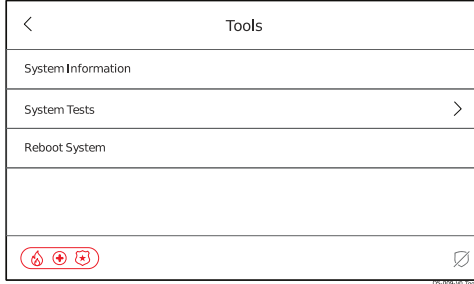
System Information

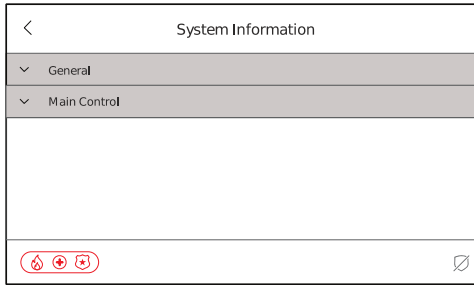
Touchscreen Display	Description
	<ol style="list-style-type: none"> 1. Select . 2. Scroll down then select "Tools" . 3. Enter the Master or Partition Master code in the displayed keypad. 4. Select "System Information".
	<ol style="list-style-type: none"> 5. Select the "Down Arrow" to expand each option. "General" displays the current version of the PROA7/PROA7PLUS system. "Main Control" displays information such as MAC addresses and ID numbers.



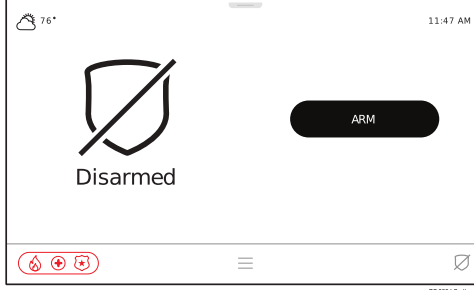
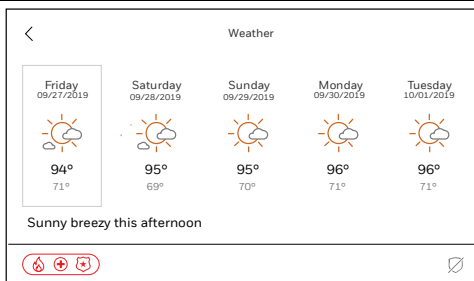

Weather

The weather feature provides the current weather status in the top-left corner of most screens along with a 5-day forecast which is updated every hour with a Wi-Fi connection, and once a day over Cell communication.

Touchscreen Display	Description
	<ol style="list-style-type: none"> 1. To view your local 5-day weather, select the "Weather" icon.
	<ol style="list-style-type: none"> 2. The displayed weather may not be accurate until setup is complete. Your dealer configures this during the installation of your system.

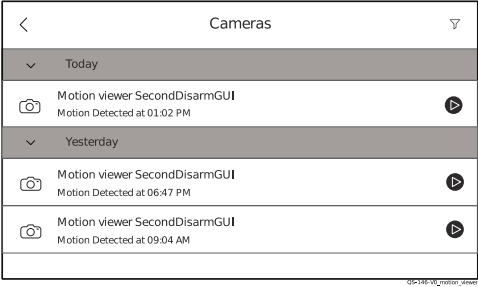
Cameras

The PROA7PLUS Control Panel has a built-in camera above its screen which takes a picture of the person who is disarming the system (does not apply to the PROA7). Additionally, if your Installer has installed any Motion Viewers, their pictures and videos can be viewed in "Cameras" along with the built-in camera disarm pictures.

Touchscreen Display	Description
	<ol style="list-style-type: none">1. Select .2. Select "Cameras" .3. A list of pictures taken upon disarming at the Control Panel is displayed. Select  to view the desired picture.

Operating the Security System (Continued)





Wi-Fi Setup

Your Dealer typically sets this up for you during the initial installation of your system. If you ever change your router or its SSID (network name) and / or the password, you need to reconnect the system to your network using the following steps.

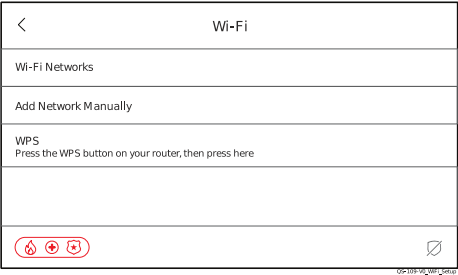

There are 3 different methods available to connect to your network. Select the best one for your application.

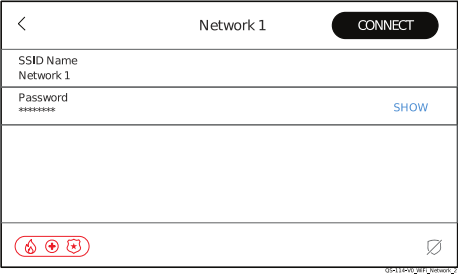
- “Wi-Fi Network” – Allows you to select your SSID (network name) from a list, then, type in your network password. This is the typical method.
- Add Network Manually – Best used when your SSID is not being broadcasted from your router. Enter both the SSID and password manually to connect.
- WPS (Wi-Fi Protected Setup) – Allows connection without knowing the network name or password. Your router must support this feature.

Selecting Wi-Fi Network

Touchscreen Display	Description
	<ol style="list-style-type: none">1. Select .2. Scroll down and select “Settings” .3. From the right, select “Wi-Fi”4. Enter the Master or Partition Master code in the displayed keypad.5. Select “Wi-Fi Networks”.
	<ol style="list-style-type: none">6. The system scans all broadcasted networks. Select your network from the list provided.7. Select “Password”. NOTE: Be sure to use a strong Wi-Fi password. Weak Wi-Fi passwords can allow an attacker to brute force into the network, which can lead to attempts to compromise the security panel.8. Enter the password to your network in the displayed keyboard.9. Select .10. Verify all information has been entered correctly.11. Select  and the system indicates connection status.12. Once connected, it displays the connected network above the available networks.13. Select < to go back in screens. <p>NOTE: All entries are characters and case sensitive.</p>

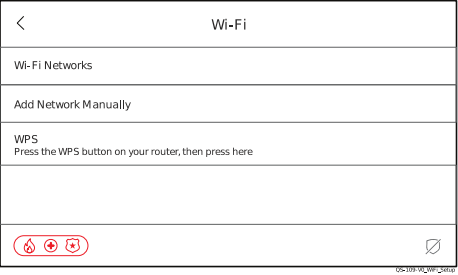
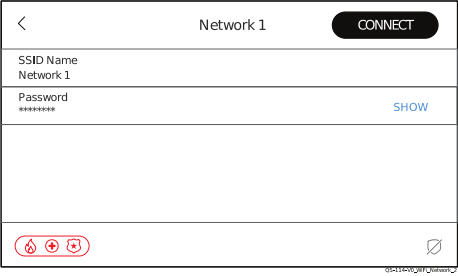
Add Network Manually

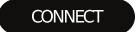
Touchscreen Display	Description
	<ol style="list-style-type: none">1. Select “Add Network Manually”.
	<ol style="list-style-type: none">2. Select “SSID Name”.3. Enter the SSID Name to your network in the displayed keyboard.4. Select .5. Select “Password”.6. Enter the password to your network in the displayed keyboard.7. Select .8. Verify all information has been entered correctly.9. Select  and the system indicates connection status.10. Once connected, it displays the connected network above the available networks.11. Select < to go back in screens. <p>NOTE: All entries are character and case sensitive.</p>

Wi-Fi Setup (Continued)

WPS Setup

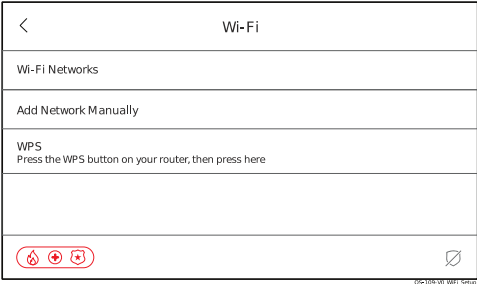
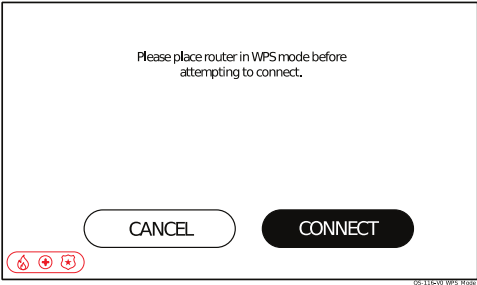
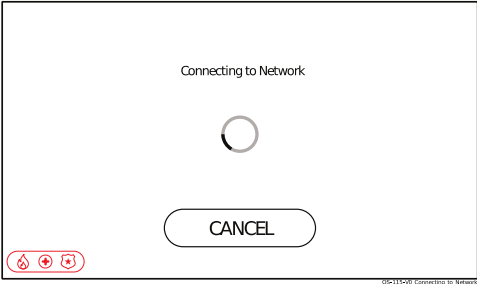
Touchscreen Display	Description
	<p>1. Select “WPS”.</p>
	<p>2. Activate WPS on your router. Refer to your router’s instructions on how to do this.</p> <p>3. Select CONNECT.</p>
	<p>4. The system displays connection status.</p> <p>NOTE: It may take a minute or two for the system to connect. If it does not connect typically within 2 or 3 minutes, depending on the router, the WPS session in the router stops and the process must be repeated or use a different connection method. If they do not connect, try bringing the Control Panel within a few feet of the router and see if they connect. Once connected, mount the Control Panel back in the desired location.</p> <p>5. Once connected, it displays the connected network above the available networks.</p> <p>6. Select < to go back in screens.</p>

Introduction to Automation

Your PROA7/PROA7PLUS is a Primary Z-Wave Controller which controls a mesh network of wireless Z-Wave and Z-Wave Plus™ devices. This system may be used with all devices certified with the Z-Wave Plus certificate and should be compatible with such devices produced by other manufacturers. Z-Wave products are “included” into the Controller, so once they are programmed, each device is assigned a unique address which allows them to communicate with each other and cannot be activated by a neighbor’s Z-Wave automation system. Z-Wave is a wireless protocol that many manufacturers can add to their products such as in-wall light switches, in-wall outlets / receptacles, plug in lamp / appliance modules, thermostats, door locks, garage door openers, and many more. Many Z-Wave devices are available at your local hardware stores or online. These devices can be individually controlled locally from the Control Panel and Touchscreens, manually at each device, or remotely from the Total Connect 2.0 app. The PROA7/PROA7PLUS can control as many as 78 Z-Wave devices, which are sold separately.

Every device is enrolled into the system differently and some are more difficult than others. We highly recommend hiring a professional to install devices such as thermostats, in-wall switches, receptacles, and door locks. Other devices such as plug-in lamp modules can be easily added to your automation system, typically by the push of a button. Z-Wave home control networks are designed to work properly alongside wireless security sensors, Wi-Fi, Bluetooth and other wireless devices. Some 900MHz wireless devices such as baby cams, wireless video devices and older cordless phones may cause interference and limit Z-Wave functionality. Contact your Dealer for compatible Z-Wave and Z-Wave Plus™ devices.

Z-Wave Range

The PROA7/PROA7PLUS security system complies with the Z-Wave Plus standard of open-air, line of sight transmission distances of 500 feet. Actual performance in a home depends on the number of walls between the Control Panel and the destination device, the type of construction and the number of Z-Wave devices installed in the Z-Wave network.

- Each wall or obstacle between the remote and the destination device can reduce the maximum range of 500 feet by approximately 25-30%. Refrigerators, large TV’s, mirrors, etc. can reduce range by much more or completely block a signal.
- Brick, tile or concrete walls block more of the RF signal than walls made of wooden studs and drywall.
- Wall-mounted Z-Wave devices installed in metal junction boxes suffers a significant loss of range (approximately 20%) since the metal box blocks a large part of the RF signal.

Additional Z-Wave Information

- Many Z-Wave devices communicate with each other to make sure signals get from the Controller to the destination device, so the more devices in the Z-Wave network, the better they work and the more stable the network becomes. A signal can hop from device to device 4 times to get to the destination device. Battery operated devices, such as door locks, do not hop signals to other devices. This is to conserve battery power. Only constant powered devices can hop signals. The Controller learns the best path (from device to device) in the network to get a signal to the destination device.
- There can be 1 primary controller with multiple secondary controllers in a Z-Wave network. If you have a scenario where a different manufacturer’s controller needs to be primary, perform a “Shift Controller” command which shifts the primary to secondary and secondary to primary, making the PROA7/PROA7PLUS the secondary controller. If this controller is being used as a secondary controller in the network, use this procedure to reset this controller only if the network primary controller is missing or otherwise inoperable.
- When included as a secondary controller, this device can support Association command class Group 1 (aka Lifeline) up to 3 node ID’s.
- Each Z-Wave device knows when it is learned into a Z-Wave network. Once it is included into a network, it cannot be learned into a different one until it is excluded from the existing one.
- The system is not aware of door locks being enabled with any temporary user shutdown feature such as Vacation Mode. The system continues to lock / unlock a door if programmed to do so.
- Certain model of Z-Wave door locks with thumbturns allow a brief period in which the thumbturn can be operated manually before the device locks automatically. Locks of this type are not recommended for use with Scenes.
- Some Z-Wave devices may not communicate low-battery notifications. Please pay attention to low battery indications on individual devices and replace batteries when the notifications appear.
- The Control Panel issues a “Failed” status on Z-Wave devices when it does not receive a response back from that device. These devices are indicated by a  symbol on the Z-Wave Device Management menu. This can be due to range, interference, or the device itself. If the Control Panel receives a signal from the device, the “Failed” status clears.



IMPORTANT

Automation can ONLY be used for lifestyle enhancement. It must not be used for personal safety or property protection nor for use to control power to medical or life support equipment!











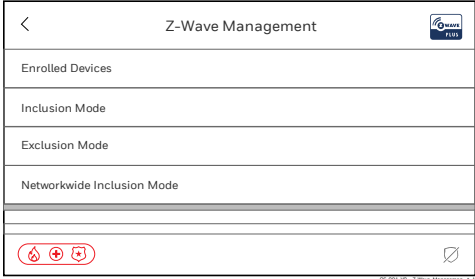

Z-Wave automation functionality is supplementary only and has not been evaluated by compliance agency.

Adding Automation Devices

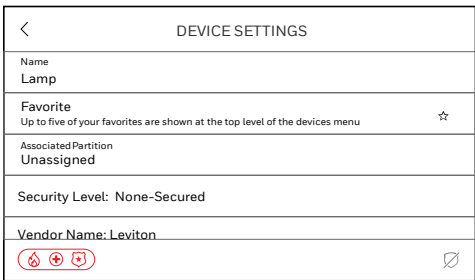
The following procedure explains how to “Include” Z-Wave products along with explaining other Z-Wave features. When accessing this feature, there are options for the following:







- **Update Network** – Use this after adding, removing, or relocating a Z-Wave device. This allows the panel to remap signals to each device in the network.
- **Remove All Failed Devices** – Any device that has failed can be removed from the Controller with this function. Use only when the device does not work in any location and has been proven bad.
- **Reset Controller** – If the Control Panel is the primary controller for your network, resetting it results in the devices in your network to be orphaned and is necessary after the reset to exclude and re-include all the devices in the network. This defaults the Z-Wave Controller in the system which removes all programmed Z-Wave devices, however, the devices do not receive a signal to be excluded. So, when they need to be included, they need to be excluded first. Do this only if you’ve been instructed by your Dealer.
- **Shift Controller** – Shifts the PROA7/PROA7PLUS to secondary Controller in case you have a different manufacturer’s Controller that needs to be primary. A Z-Wave network can have one primary controller with multiple secondary controllers.

Touchscreen Display	Description
	<ol style="list-style-type: none"> 1. Select . 2. Select “Devices” . 3. From the right, select “Z-Wave Management”. 4. Enter the Master or Partition Master code in the displayed keypad. 5. Select “Inclusion Mode” if the device being added is very close to the Control Panel and can signal directly to it. Select “Network Wide Inclusion” if the device supports it, which is included through hopping signals through the Z-Wave network. NOTE: If the device is an S2 security device, the panel will ask for the DSK (Device Specific Key) pin. Enter the PIN from the device.
	<ol style="list-style-type: none"> 6. The system is ready to include a device. Activate the device and allow up to one minute for the device to include. <p>NOTES:</p> <ul style="list-style-type: none"> • Each type of Z-Wave device has its own unique way to initiate its inclusion process. Please refer to your devices instructions on how to include it into a Z-Wave Controller. • Some devices, such as door locks, may require to be within 3 feet of the Control Panel to be included into the network. Once included, it can be installed in the desired location.
	<ol style="list-style-type: none"> 7. It indicates “1 Device Included”. Select . If a device is not including, try the following: <ul style="list-style-type: none"> • If possible, bring the Z-Wave device within 3 ft of the Control Panel. • Try going through the excluding procedure in the next section. If the device was tested in a different network and not excluded, it does not include into a different network until it receives an excluded signal. Then, try to include it again.
	<ol style="list-style-type: none"> 8. By default, when a device is included into the system, it has its own generic name such as “Device 1” or something similar. To rename the device, touch the device name on the left side. 9. Enter the desired name of the device in the displayed keyboard 10. Select . NOTE: Up to 40 characters can be used to create a name, however, only the first 25 characters are shown in the “Favorites” screen, which is covered later. 11. Select  to go back to the device’s full screen. 12. Select  to go back to previous screen.

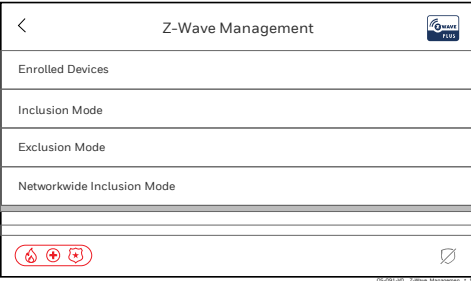
Automation (Continued)

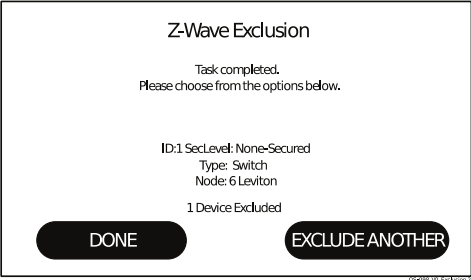

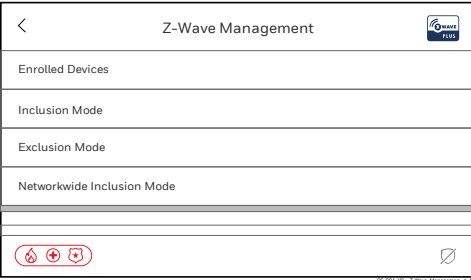

Removing Automation Devices

The following procedure explain how to exclude Z-Wave products from a Z-Wave network, so they can be used in a different network. This can also be used if you are having problems including a device in to a network, which allows a device to be included after being excluded.

Touchscreen Display	Description
	<ol style="list-style-type: none">1. Select .2. Select "Devices" .3. From the right, select "Z-Wave Management".4. Enter the Master or Partition Master code in the displayed keypad.5. Select "Exclusion Mode".
	<ol style="list-style-type: none">6. It prompts you to exclude Z-Wave device by pressing the function button on the device. Typically, you would exclude the device the same way it was included. See the instructions for that device for further details.7. It indicates "1 Device Excluded". Select  or continue excluding more devices if needed.
	<ol style="list-style-type: none">8. After you select , the "Z-Wave Management" page is displayed. Select  to go back to the main screen.

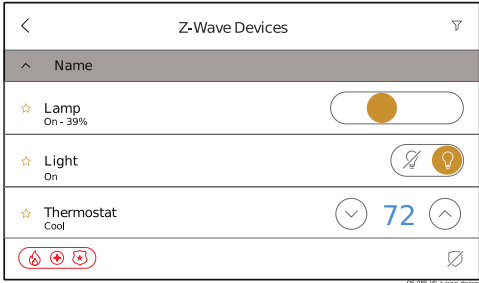
Operating Your Automation System

Some plug-in modules are dimmable while others are not. They are simply on or off. The same applies to in-wall switches and receptacles. There are many different manufacturers of Z-Wave devices available and they all have their own Z-Wave feature sets that look and operate differently from the devices in the following examples.

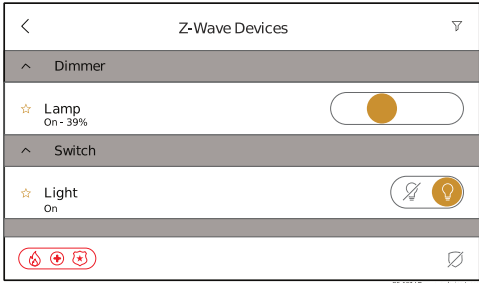

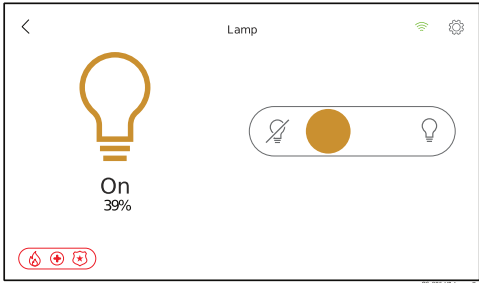
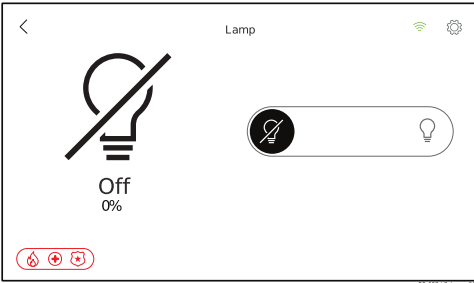
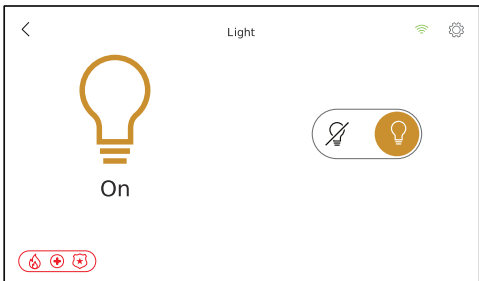
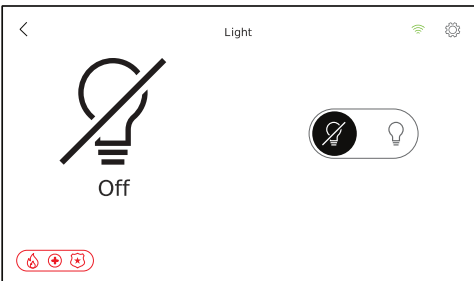
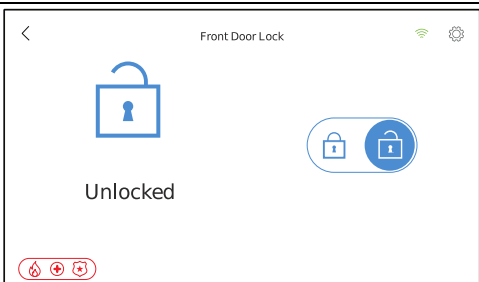
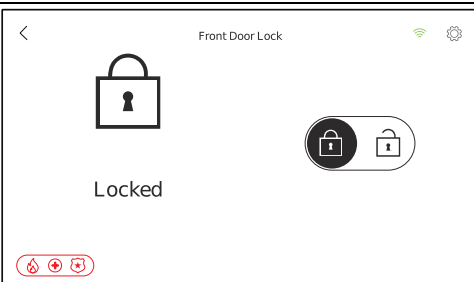

Touchscreen Display	Description
	<ol style="list-style-type: none"> 1. Select . 2. Select Devices . 3. From the right, select "All Devices". "All Devices" lists all enrolled Z-Wave devices that your Dealer may have installed for you. The following examples show 2 plug-in modules, a thermostat, and a door lock. 4. Each device is controllable from this screen by activating each action icon on the right side. Touch the name of each device on the left side to access the full screen for that device. 5. Select  to change the display of how the devices are listed. Select between "Device Type" or "Device Name". This example displays the list by "Device Name". Scroll down to see more devices.
	<ol style="list-style-type: none"> 6. "Device Type" categorizes all devices by "Switch", "Dimmer", "Thermostat", "Lock", etc. 7. Select the name of a device on the left side to see it in full screen.

Full screen displays highly visible icons for device activation and status.

		<p>For the dimming devices, touch and drag the control to the left or to the right until the desired level is reached.</p>
		<p>For the on / off devices, simply touch the on / off icon on the right.</p>
		<p>For door locks, select the lock / unlock icon on the right to unlock it.</p>

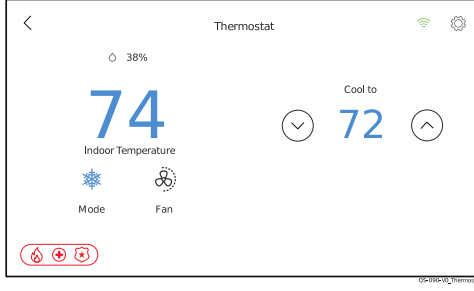

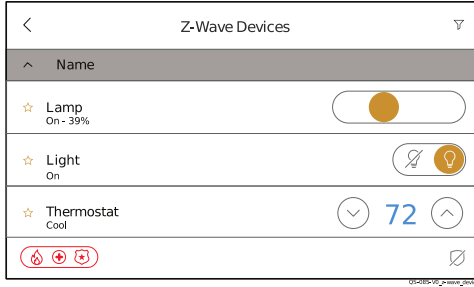
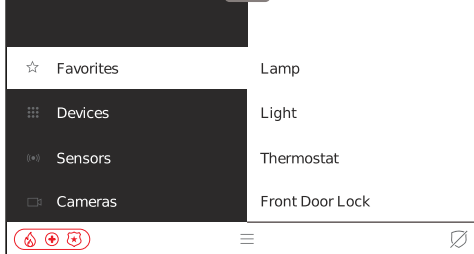

Automation (Continued)

Operating Your Automation System (Continued)

Touchscreen Display	Description
	<p>For thermostat control, adjust the desired temperatures by selecting the up and down arrows on the right along with the Mode and Fan controls on the left. When changing the Mode and Fan controls, touch each icon, then, a pop-up window is displayed with selectable options for each.</p> <p>The name of any device can be changed anytime from its full screen:</p> <ol style="list-style-type: none"> 1. Select . 2. Select the device name on the left to access the keyboard. 3. Enter the new name of the device. 4. Select .
	<p>Up to 5 of your favorite Automation devices can be added to the “Favorites” screen for easy access. Accomplish this by selecting the “star” on the left side of each device. Once it is yellow, it is displayed in the “Favorites” screen.</p>
	<p>To access “Favorites”, simply select . “Favorites” is always the first option displayed. When accessing a device from the “Favorites” screen, it displays it in full screen.</p> <p>NOTE: While the name of any Z-Wave device can be up to 40 characters, this screen can only display up to 25 characters for any device name.</p>

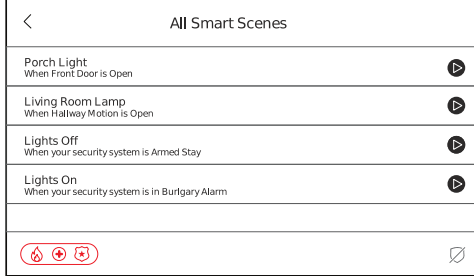
Scenes

Scene programming allows you to automate your Z-Wave devices by programming different security system events to trigger Z-Wave device activations. Up to 20 scenes can be programmed, but only from Total Connect 2.0. (www.totalconnect2.com or use the TotalConnect2.0 App) Once programmed and synced with the Control Panel, all scenes can be viewed and “ran” from the Control Panel and Touchscreens.

Touchscreen Display	Description
	<ol style="list-style-type: none"> 1. Select . 2. Scroll down and select “Scenes” . 3. To run a scene, simply select  to the right of the scene and the Z-Wave device operates based on the scene’s command.
	<p>There are many different options to automate your Z-Wave devices. Scenes can be activated based on time schedules, manually, or when triggered by a device in your system, such as a sensor fault or system arming / disarming. Other than the ones in this example, here are some other popular scenes:</p> <ul style="list-style-type: none"> • Turn on / off desired lights with a Key Fob. • Turn on porch light when driveway motion sensor is faulted. • Lock desired door locks when armed in any mode. • Change thermostat modes based on arming / disarming or other system functions. • Schedule desired lights to turn on / off at desired times, including sunrise / sunset. • Schedule arming of the security system at desired times for Partition 1.

Alexa

If you want the Alexa feature, it must be enabled in your system by your Dealer (PROA7PLUS control panel only). If you are unable to setup the Alexa feature in the procedure below, contact your Dealer to enable Alexa. Each Touchscreen installed on your system, including the Control Panel, is considered a separate device to Alexa. The following setup procedure must be performed on the Control Panel and each Touchscreen as desired. In the devices section of your Alex app, the Control Panel is identified as “QSAIO” (All-In-One) while each Touchscreen is identified as “WTS” (Wireless Touch Screen).

The Control Panel and Touchscreens supports a variety of general Alexa skills:

- Weather Update
- Flash News Briefing
- Sports Updates
- Stock Updates
- Local Traffic & Drive Time
- Recipes / Meal Ideas / Wine Pairing
- Math Calculations
- Distance Calculations
- Timers
- Alarms
- To Do Lists
- Add Events to Calendar
- Shopping Lists
- Direct Shopping
- Reminders

NOTE: Phone Calls are NOT supported on the Control Panel or Touchscreens.







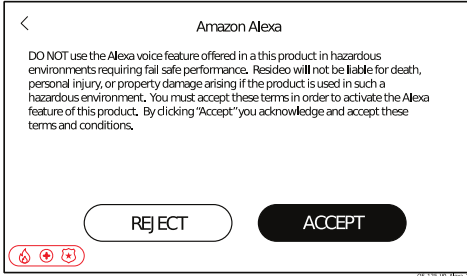

If your Dealer has setup Total Connect 2.0 with your system, link your Total Connect 2.0 account as a skill through your Alexa app. You need to link them with your Total Connect 2.0 username and password. Once they are linked, the following commands can be performed through your Alexa devices:

- “Alexa, ask Total Connect “What is the status of my security system?””
- “Alexa, ask Total Connect, “Is my security system armed?””
- “Alexa, tell Total Connect to Arm.”
- “Alexa, tell Total Connect to Arm Away.”
- “Alexa, tell Total Connect to Arm Stay.”
- “Alexa, tell Total Connect to run bedtime”. (Bedtime can be a scene programmed to turn lights off and arm the system).
- Any programmed scene can be activated from Alexa, except for scenes that unlock doors or Disarm the system

NOTES:

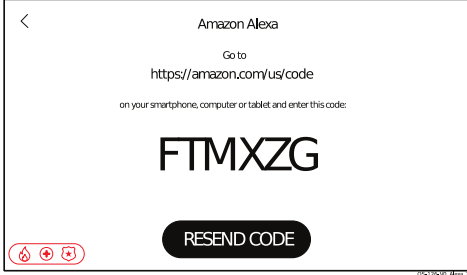
- Any Automation Scene programmed to run when the system is armed activates when you tell Alexa to arm your system.
- For security purposes, you cannot disarm your system using Alexa. Alexa is not associated with any User Codes in your system. Disarming requires the entry of a valid 4-digit code.
- For multi-location Total Connect 2.0 accounts, only one location in Total Connect 2.0 is supported per each Alexa account.
- For multi-partition Control Panels, only partition 1 is supported.

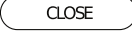
The following procedure explains how to setup Alexa on the Control Panel and Touchscreens.

Touchscreen Display	Description
	<ol style="list-style-type: none"> 1. Select . 2. Scroll down and select “Settings” . 3. From the right, select “Voice Services.” 4. Select “Amazon Alexa”. 5. Select “Enrollment”. 6. Enter the Master or Partition Master code in the displayed keypad. 7. Read the End User License Agreement carefully. To accept the agreement, select . If you do not agree, select .
	<ol style="list-style-type: none"> 8. Once you accept the license agreement, you are prompted to go to the amazon web site as described on this screen. Log into your Amazon account with your username and password. Enter the 6-digit code provided from this screen into Amazon site. 9. When the Amazon web site has indicated “Success! Your registration is complete.”. The screen automatically updates and indicates “Login Successful”. Select .
	<ol style="list-style-type: none"> 10. Select . Access this screen again by following steps 1-3. <p>If you , then Alexa is not available on the device from which you logged out. To re-enable the device, you need repeat steps 1-9 again on the device from which you logged out from.</p>

Automation (Continued)

Alexa (Continued)

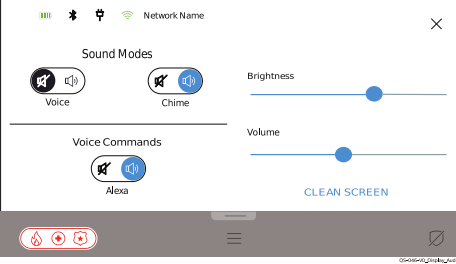
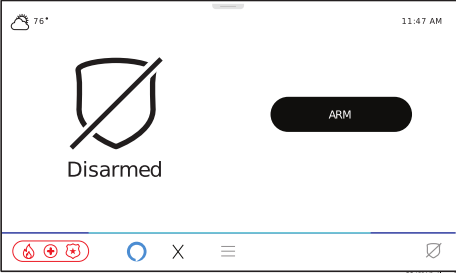



Touchscreen Display	Description
	<p>After the Alexa feature has been enabled on the Control Panel and each Touchscreen, the “Display & Audio Settings” screen displays a toggle button for Alexa Voice Commands on each enabled device. If Alexa is not enabled on a Touchscreen, Alexa Voice Commands are not displayed here. When Alexa Voice Commands is enabled, it turns blue and Alexa can be used with all available features. If disabled, Alexa cannot respond to any commands until it has been turned back on.</p>
	<p>The Alexa icon is displayed in the bottom of the Home screen. Anytime Alexa is prompted, the bottom bar above the Alexa Logo animates in accordance with the Alexa operation and an X is displayed next to the Alexa icon to stop any announcements. The bottom bar also flashes yellow when there is an Alexa notification and turns red if Alexa Voice Commands has been disabled.</p>

Bluetooth Disarm

If the “Bluetooth Disarm” feature has been enabled by your Dealer (PROA7PLUS only), the system disarms as soon as a user’s Bluetooth device is connected to the system. Multiple devices can be paired per user, but up to a maximum of 6 Bluetooth devices in the system. Each of the 6 Bluetooth devices can be setup in the Control Panel and each Touchscreen.

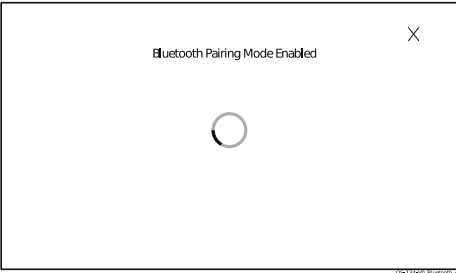
IMPORTANT SECURITY NOTICE

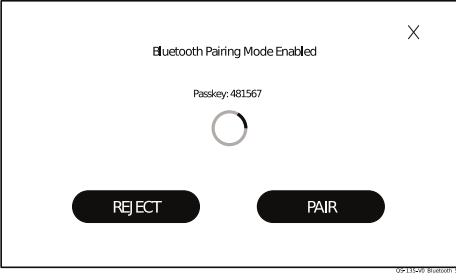
Your Bluetooth device is similar to your house keys. If lost or stolen, another person can compromise the security system. Immediately notify your Dealer of a lost or stolen Bluetooth device. Your Dealer can then disable Bluetooth programming from the security system.

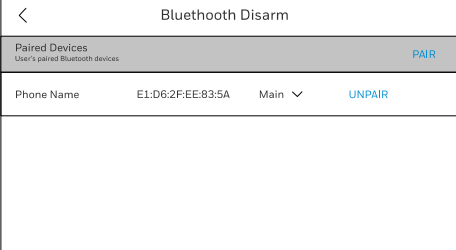
Touchscreen Display	Description
	<ol style="list-style-type: none"> 1. Select . 2. Scroll down and select “Settings” . 3. From the right, select “User Management”. 4. Enter the Master or Partition Master code in the displayed keypad. 5. Select the desired user from the list. 6. Scroll down in the user and select “Bluetooth Disarm”. 7. Select “PAIR”. 8. Enable Bluetooth in the device and look for the Control Panel or Touchscreen. It is labelled “ProSeries-XXXXX”, where X is the last 5 digits of its MAC.
	<ol style="list-style-type: none"> 9. The Control Panel or Touchscreen provides a 6-digit passkey. You may need to enter this on your device or it may display automatically. Select “PAIR” on your device and select  on the Control Panel or Touchscreen.
	<ol style="list-style-type: none"> 10. Once paired, the Control Panel displays the connected device, its MAC, Partition assignment and its connection status. There is the option to “UNPAIR” or toggle the disarm feature on and off for the user’s device.

Maintenance



The system is designed to require little maintenance. However, testing your system is strongly recommended while regular care and cleaning is suggested.

Software Updates

Software updates for the Control Panel are published periodically. Most updates requests user permission. Select **Accept**, **Yes** or **OK** to install the update. Certain critical updates are installed automatically. After critical updates, information about the update appears on-screen and the system reboots.

Care and Cleaning

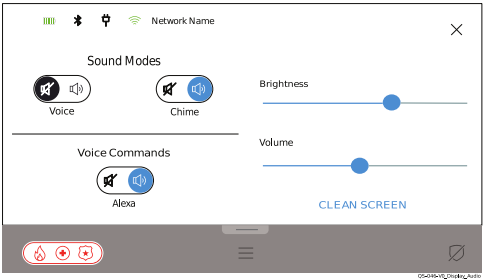
- Do not slam sensor-protected doors or windows. This could potentially damage the sensor.
- Keep dust from accumulating on the Touchscreen and sensors, particularly motion sensors and smoke / carbon monoxide detectors. We recommend cleaning them monthly with a soft, dry cloth.

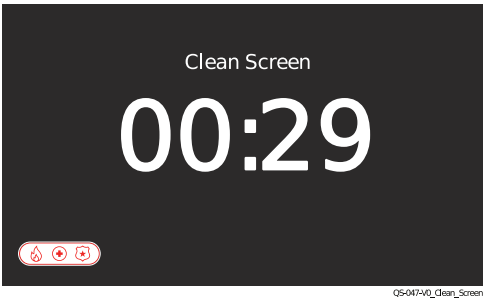
Touchscreen Display	Description
	<ol style="list-style-type: none">1. Touch and drag down the Display & Audio Settings tab  at the top of the screen.2. Select "CLEAN SCREEN".
	<ol style="list-style-type: none">3. The screen displays a 30 second countdown, disabling it so it can be cleaned using a clean, soft, dry cloth. Do NOT spray or use any cleaning solutions on the screen!

Screensaver

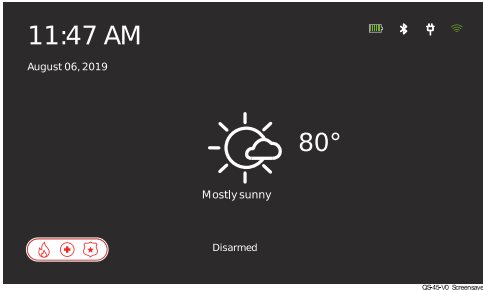
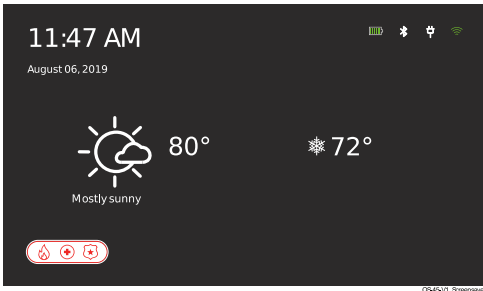





Touchscreen Display	Description
	<p>After 5 minutes of no activity, the screen enters Screensaver mode and display the current time / date, weather, and other critical status.</p>
	<p>If there is a Z-Wave thermostat programmed in Automation, the Screensaver also displays the current status of your primary thermostat on the right.</p>

Maintenance (Continued)

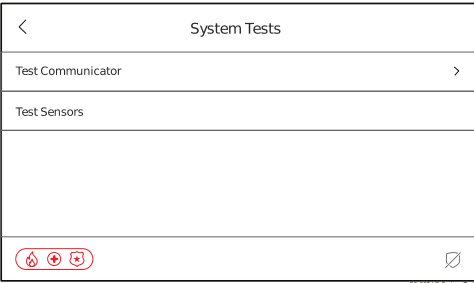

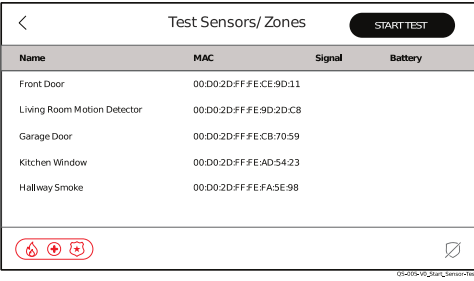
Testing the Sensors

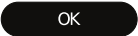
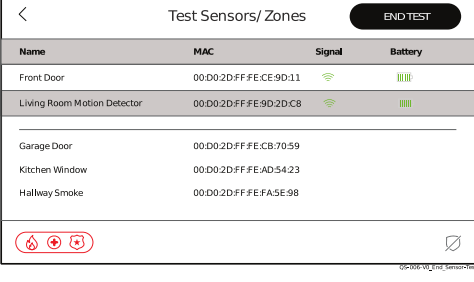
- Test the system monthly.
- Test your system after any alarm occurs.

Before testing, the system should be disarmed, and all protected doors and windows closed. The status LED shows green when “Ready to Arm”. This test mode can be entered while sensors are faulted, but you must still close and open these sensors to test them. Testing your sensors with the following test mode does NOT send any signals to your central station. Instead, it tests ONLY the range and operation of the sensors with your PROA7/PROA7PLUS security system. To test actual alarm signals with your central station, please contact your Dealer or Central Station for their process on how to do so. This requires the system to go into an alarm condition which is accomplished by either activating a panic or arming the system and faulting sensors.

Touchscreen Display	Description
 <p>The screenshot shows a touchscreen interface titled "System Tests". At the top left is a back arrow and the title. Below the title are two menu items: "Test Communicator" and "Test Sensors". At the bottom left, there are three circular icons: a flame, a plus sign, and a minus sign. At the bottom right, there is a shield icon.</p>	<ol style="list-style-type: none">1. Select .2. Scroll down then select “Tools” .3. Enter the System Master code in the displayed keypad.4. Select “System Test”.5. Select “Test Sensors”.
 <p>The screenshot shows a touchscreen interface titled "Test Sensors/ Zones". At the top right is a "START TEST" button. Below the title is a table with columns: Name, MAC, Signal, and Battery. The table lists five sensors: Front Door, Living Room Motion Detector, Garage Door, Kitchen Window, and Hallway Smoke. At the bottom left, there are three circular icons: a flame, a plus sign, and a minus sign. At the bottom right, there is a shield icon.</p>	<ol style="list-style-type: none">6. This displays all sensors / sensors programmed in your system. Select .7. The screen displays “Start Sensor Test”. Select . The PRO7APLUS sound their alarm sounder for 2 seconds. <p>NOTE: Testing sensors is done by partition. You must log onto the other partition to test their sensors.</p>
 <p>The screenshot shows a touchscreen interface titled "Test Sensors/ Zones". At the top right is an "END TEST" button. Below the title is a table with columns: Name, MAC, Signal, and Battery. The table lists five sensors: Front Door, Living Room Motion Detector, Garage Door, Kitchen Window, and Hallway Smoke. The Living Room Motion Detector row is highlighted. At the bottom left, there are three circular icons: a flame, a plus sign, and a minus sign. At the bottom right, there is a shield icon.</p>	<ol style="list-style-type: none">8. The sirens and smoke / CO sensors displays their signal strength and battery levels on the screen. As you activate all other sensors, the system provides 3 beeps along with the voice annunciation of the sensor descriptors. This applies to all sensors, including motion detectors. As the panel recognizes each sensor, it displays their respective wireless signal and battery levels. Once the test is complete, select . <p>NOTES:</p> <ul style="list-style-type: none">• Wireless motion detectors utilize a 3-minute timeout when they are faulted. This means when you walk through their coverage area, they send a fault signal to the Control Panel, then sends a restore signal immediately thereafter to clear the fault. After sending the restore signal, they go to “sleep” for 3 minutes to conserve battery life. After 3 minutes, it wakes back up to its active state and waits to detect motion again and repeats the process. If a motion detector is NOT showing in this list as activated (displays signal and battery status), give it up to 3 minutes before walking through its coverage area again.• When testing smoke detectors, keep the Control Panel in test mode for at least one minute (60 seconds) after testing the detector to avoid sending unwanted alarm messages to the Central Station• If you experience any problems getting any sensor to test with the system, please contact your Dealer.

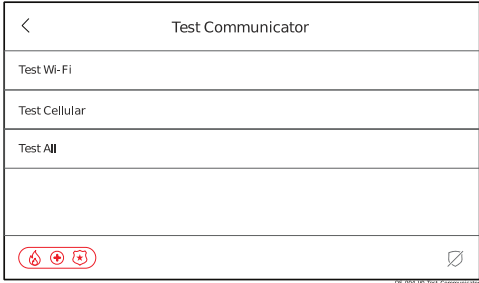
Testing the Communicators

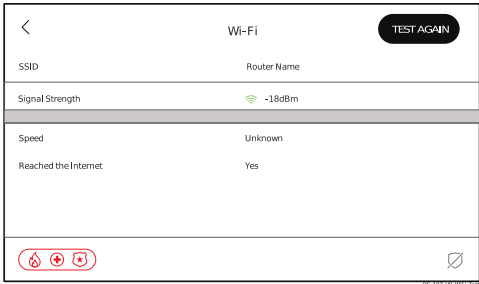
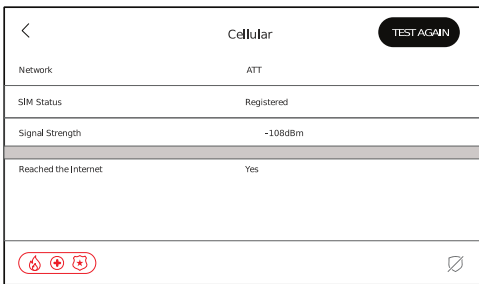
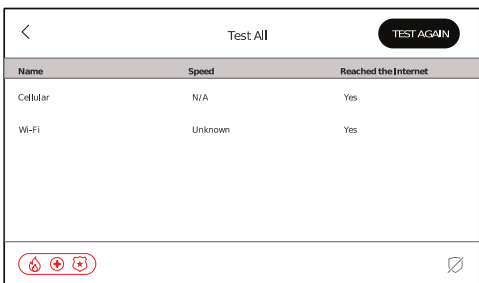
Touchscreen Display	Description
	<ol style="list-style-type: none"> 1. Select . 2. Scroll down and select "Tools" . 3. Enter the Master or Partition Master code in the displayed keypad. 4. Select "System Test". 5. Select "Test Communicator". 6. Select "Test Wi-Fi", "Test Cellular" or "Test All".
	<p>6A. "Test Wi-Fi" provides information such as the name of the network it is connected too, Signal Strength in dBm, speed, and internet connection.</p>
	<p>6B. "Test Cellular" provides information such as the name of the cell network it is connect too, SIM Status, Signal Strength in dBm, and internet connection.</p>
	<p>6C. "Test All" provides information for both Cellular and Wi-Fi such as internet connection and speed.</p>

System Battery

IMPORTANT

The battery pack must be replaced when the Alert displays **System Low Battery** with no sensor number specified. Contact your Dealer to replace the battery.

Sensor Batteries

IMPORTANT

The Control Panel beeps once every 40-45 seconds when a sensor reports a low battery. A sensor with a low battery continues to operate for up to 30 days. However, the battery must be replaced within 30 days of the audible warning beginning. The sensors draw quick bursts of current during transmission, then sit idle with very nominal current draw. Most batteries are not designed for this type of use, therefore, only batteries listed as compatible should be used if the expected battery life is to be attained. Please check with your Dealer for compatible battery manufacturers and their part numbers when they need to be changed. When other non-approved batteries are used, the quick bursts of current draw kill the battery cells prematurely causing them to go low in a matter of months and can also cause unpredictable results. Other low-quality batteries have not been UL tested and pose a safety hazard if used. After the battery has been changed, clear the sensor low-battery and tamper Alerts by acknowledging it. For SiX™ series sensors and wireless keys, remove the old battery and wait about 10 seconds before installing the replacement battery.

Wireless Touchscreens, Keypads, & Key Fobs

PROWLTOUCH Wireless Touchscreen

Wireless Touchscreens (if installed), are functionally the same as the Control Panel. They duplicate the Control Panel's displays and functions. Most of what can be done at the Control Panel can also be done at the Touchscreen. The Touchscreens communicate to the Control Panel via Wi-Fi through your router. It can be either wall mounted with the wall docking station or desk mounted with either the built-in desk stand or separate optional desk mount. The built-in desk stand option angles the touchscreen at approx. 30°. Touchscreens are NOT supervised by the system. If a Touchscreen loses wireless connection to the Control Panel, it displays a black screen with "Please Standby". This message clears and displays status once it reconnects.

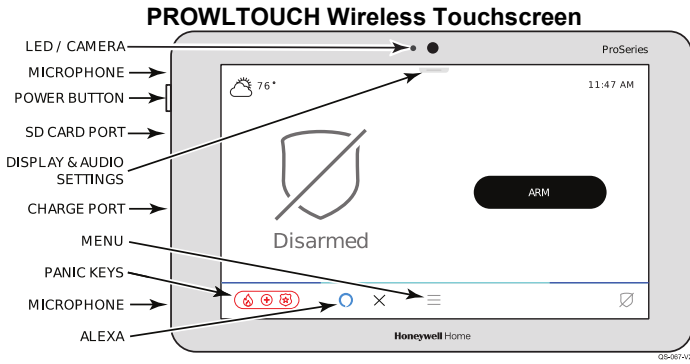

Status LED	Meaning
Red - Steady	System Armed
Red - Flashing	Alarm / Alarm Memory
Amber - Steady	System trouble
Amber - Flashing	Device trouble – System cannot be armed
Green - Steady	Ready to Arm
Green - Flashing	Device trouble - System can be armed
Green & Red Alternately Flashing	System is in Programming Mode
Off	Not ready to Arm

NOTE: The power button has 2 distinct functions:

- Press and Release to toggle the screen off and on.
- Press and Hold to display the options of Power Off or Restart.

Touchscreen Mounting Options

Built-In Desk Stand

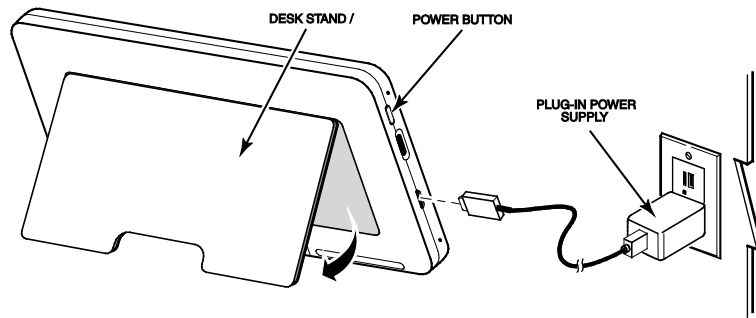

The Touchscreen can be powered by the supplied micro USB cable and the 5Vdc, 1.5A plug-in transformer. For optimal performance, use the supplied transformer to charge the Lithium Ion Polymer battery. The battery may not charge properly if it's plugged into any other USB port.

Wall Mount (Sold Separately)

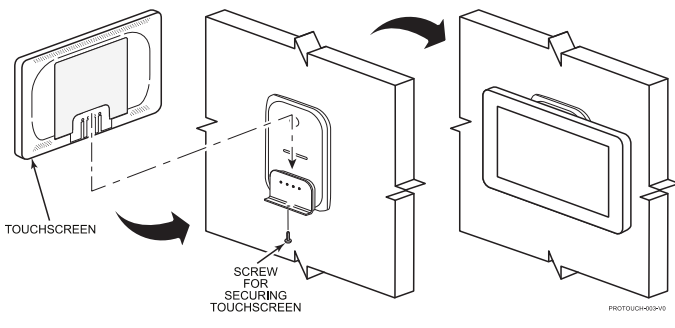

Desk Mount (Sold Separately)

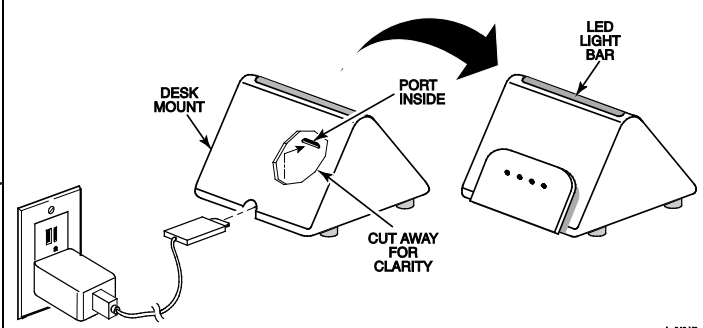

Wireless Touchscreens, Keypads, & Key Fobs (Continued)

PROSiXLCDKP Wireless Alpha Keypad

The PROSiXLCDKP Wireless Alpha Keypad provides a LCD display with 2 lines of 32 total characters allowing it to display the Keypad's partition number, system status, sensor status, and various messages. This non-voice Keypad also displays programmed descriptors such as "Front Door", "Kitchen Window", etc. anytime the sensors are faulted. If Chime is enabled on the Control Panel, this Keypad provides the Standard 3-beep Chime sound (cannot be changed) when a zone is faulted. It also has the option of being used with a desk stand, sold separately. These Keypads are supervised. If the system loses communications with a wireless Keypad for 15 minutes, the system latches into a trouble condition, which clears automatically once it regains communication with the Control Panel. If "Arming Ding" is enabled by your Dealer, the system sounds its alarm sounder(s) when the Keypad is used to arm the system to Away mode. This is so you can hear the system arm from outside the premises.

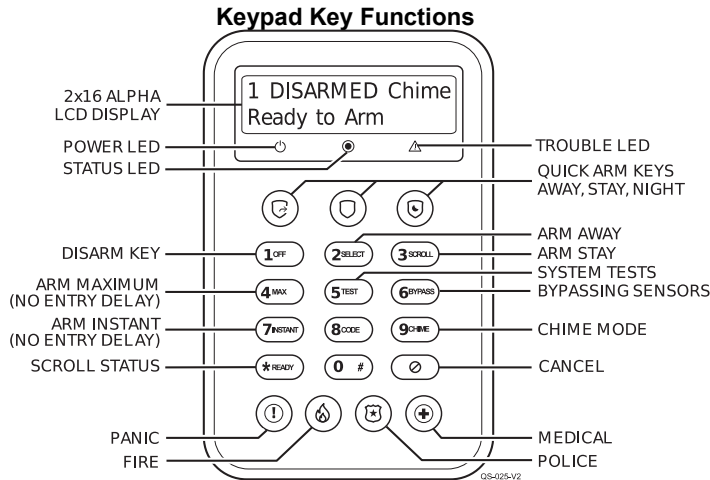

Optional Desk Stand (Sold Separately)

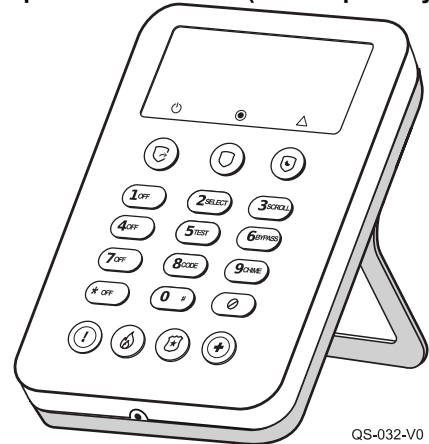

LED	Status	Meaning
POWER 	Red - Steady	No AC power is present and battery is very low.
	Green - Steady	AC power is present
	Green - Flashing	No AC is present and unit is operating on battery power
	Red - Flashing	No AC power is present and battery is low.
	Amber- Steady	Battery is charging
STATUS 	Off	System/Partition is Not Ready to Arm OR in Programming Mode
	Red - Steady	System/Partition is Armed
	Green - Steady	System/Partition is Ready to Arm
	Red - Flashing	Alarm detected OR Alarm in memory
TROUBLE 	Off	System is in Programming mode OR no troubles present
	Red - Steady	System trouble is present
	Red - Flashing	Device trouble is present

Keypad Menu Mode

This mode displays keypad programmed information and provides access to Default, Reset, LCD Brightness and Backlight options. Access the menu mode by holding the **(3 SCROLL)** key for 2 seconds. Press **(3 SCROLL)** key to scroll or the **(* READY)** key to exit. This mode exits after 1 minute of no keypad activity. See below for settings and options.

Display	Meaning / Option
App: Boot:	Displays the Keypad's current App and Boot versions
RF6:	Displays the Keypad's SiX software version and the keypad MAC ID
Default Keypad	Prompts to Default Keypad. (2 SELECT) = CONFIRM to remove keypad from Control Panel. NOTE: If the Keypad is repowered within 24 hours, it attempts to re-pair with the Control Panel. After 24 hours, it needs to be re-enrolled.
Partition= Keypad ID=	Displays Partition assignment and Keypad ID programmed in the Control Panel.
Reset Keypad	Prompts to Reset Keypad. (2 SELECT) = CONFIRM (restart)
LCD Brightness	Prompts to change LCD brightness. (2 SELECT) toggles from Low, Medium, and High
Backlight Adjust	Press (2 SELECT) to cycle through options for: Always Off / ON, After 1, 5, or 15 minutes
A: None B: None	(Future Use) (Future Use)

Wireless Touchscreens, Keypads, & Key Fobs (Continued)

PROSiXLCDKP Alpha Wireless Keypad (Continued)

PROSiXLCDKP Alpha Keypad Commands

When entering any commands, sequential key depressions must be made within a few seconds of one another. If a few seconds elapse without a key depression, the entry is aborted and must be restarted from its beginning. Be sure to observe this precaution when performing any of the commands on this Keypad. If you make a mistake while entering a command, stop, press the **(*) READY** key, and then start over. If you stop in the middle of entering a command and then immediately start the entry over, an erroneous command might be entered. All commands require a valid 4-digit code to be entered first except for Quick Arming, and Fire Silence. User Codes cannot be programmed into the system from this Keypad. They can only be programmed from the Control Panel, Touchscreens, or by your Dealer.

Action	Command
Bypassing	
If "Force Bypass" has been enabled by your Dealer and you attempt to arm with any of the arming commands below, all faulted sensors are bypassed automatically, then, the system arms. If "Force Bypass" is disabled and the sensor cannot be closed, the sensor needs to be bypassed manually so the system ignores it. Any bypassed sensor becomes unbypassed once a disarm command is entered.	
Manual Bypassing Sensors	4-digit code + (6 BYPASS) + 3-digit sensor (zone) number to be bypassed. Repeat command for each faulted sensor. If you are not sure what the zone numbers are for your sensors, ask your Dealer for a list or fill out the zone list in back of this manual.
Arming	
Away	4-digit code + (A) two beeps confirm
Stay	4-digit code + (S) three beeps confirm
Night-Stay	4-digit code + (NS) + three beeps confirm
Maximum (Away INSTANT)	4-digit code + (4 MAX) two beeps confirm (no Entry Delay)
Instant (Stay INSTANT)	4-digit code + (7 INSTANT) three beeps confirm (no Entry Delay)
Quick Arming (Enabled by your Dealer)	Press (A) (AWAY) OR (S) (STAY) OR (NS) (NIGHT STAY) (4-digit code not required)
Disarming	
The Disarm command does more than just disarm the system. It also clears alarm / trouble memory and exit test modes.	
Disarm	4-digit code + (1 OFF)
Disarm from Alarm or Trouble	Enter a valid 4-digit code + (1 OFF) twice. The first disarm silences alarm sounds. The second disarm clears the alarm / trouble memory from the display.
Fire Silence	Press (1 OFF)
Panics	
Panics are activated by 2 separate button depressions which require depressions within 10 seconds of each other, not simultaneously. When the first button is pressed, the programmed panic keys illuminate. There are 3 distinct ways to activate a Panic.	
Fire (Sensor 995)	Press (1) + (F) OR (F) + (1) OR (F) + (F)
Police (Sensor 999)	Press (1) + (P) OR (P) + (1) OR (P) + (P)
Medical (Sensor 996)	Press (1) + (M) OR (M) + (1) OR (M) + (M)
Partitioning	
Goto another Partition	4-digit code + (*) READY + partition number ((1 OFF) or (2 SELECT) or (3 SCROLL) or (4 MAX))
Miscellaneous	
Chime Mode	4-digit code + (9 CHIME) (Command toggles Chime on and off)
Start Walk Test	4-digit Master code + (5 TEST) + (1 OFF)
End Walk Test	4-digit code + (1 OFF) (Disarm)
Scroll through Status	Pressing the (*) READY key scrolls through all messages that are displayed on the Keypad.

Wireless Touchscreens, Keypads, & Key Fobs (Continued)

Wireless Key Fobs

Your system may also include one or more wireless Key Fobs, which can perform various functions programmed by your Dealer. Key Fobs are typically programmed to Arm Stay, Arm Away, Disarm, and a Panic. Additional buttons can also be used to activate / deactivate Z-Wave Automation devices, such as lights via Scenes. The system supports up to 32 Key Fobs.

IMPORTANT SECURITY NOTICE

Your wireless Key Fob is similar to your house keys. If lost or stolen, another person can compromise the security system. Immediately notify your Dealer of a lost or stolen wireless Key Fob. Your Dealer can then remove the wireless Key Fob programming from the security system.

NOTES:

- To activate a button function, press and hold the button for 1-2 seconds until the lights come on. To request system status without activating the button, press and release any button.
- Each Key Fob must be assigned to its own 4-digit User Code in the Control Panel. When a fob is used to arm and disarm, the system logs the arm and disarm events in the Activity Log along with the user's name. Two fobs can not be assigned to the same user.
- The disarm button can not only be used to disarm the system, but it can also be used to clear Alarm Memory by simply pressing it twice. The first time will disarm, silencing alarm sounds, and the second time will clear memory.
- The PROSiXFOB is bi-directional so it not only sends signals to the Control Panel, but it also receives signals back to reflect system status with its LED's.
- If "Arming Ding" is enabled by your Dealer, your system sounds its alarm sounder(s) when the fob is used to arm the system to Away mode. This is so you can hear the system arm from outside the premises.

Your wireless Key Fobs are programmed by your Dealer. Write down each button's programmed function in the spaces below.

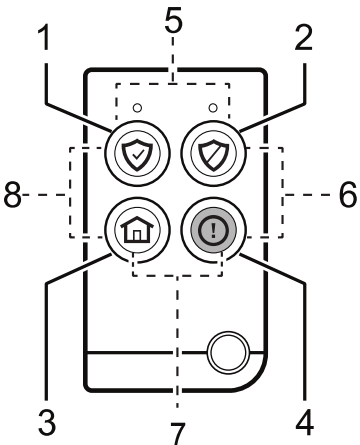
<p>Button 1: _____</p> <p>Button 2: _____</p> <p>Button 3: _____</p> <p>Button 4: _____</p> <p>Button 5: _____ <i>(press and hold BOTH buttons to activate)</i></p> <p>Button 6: _____ <i>(press and hold BOTH buttons to activate)</i></p> <p>Button 7: _____ <i>(press and hold BOTH buttons to activate)</i></p> <p>Button 8: _____ <i>(press and hold BOTH buttons to activate)</i></p>	<p>PROSiXFOB: Wireless Key Fob</p>  <p>The diagram shows a rectangular key fob with rounded corners. At the top, there are two small circular LEDs labeled '5'. Below the LEDs are four larger buttons: two with shield icons (labeled '1' and '2'), one with a house icon (labeled '3'), and one with an exclamation mark icon (labeled '4'). At the bottom center is a small circular button labeled '7'. A dashed line labeled '8' encloses the top two buttons and the house icon button. A dashed line labeled '6' encloses the shield icon buttons and the exclamation mark button.</p>
---	--

PROSiXFOB Wireless Key Status Indications

Status is indicated by the LEDs at the top of the key fob.

System Status	Green LEDs	Red LED	Sounder
System Armed (any mode)	Off	On 2-3 seconds	2 Beeps
Alarm in progress or in Audible Panic Alarm	Off	Slow Flash for 2-3 seconds	4 Beeps
Disarmed, Ready to Arm	On 2-3 seconds	Off	1 Beep
Disarmed, Not Ready to Arm	Slow Flash for 2-3 seconds	Off	Silent
RF Transmission	Flash once (both LEDs)	Off	Silent
Not Hearing from Control Panel	Off	Off	1 Second beep

NFPA Recommendations

National Fire Protection Association Smoke Detector Recommendations:

Regarding the number and placement of smoke and heat detectors, we subscribe to the recommendations contained in the National Fire Protection Association's (NFPA) Standard #72 noted below.

Early warning fire detection is best achieved by the installation of fire detection equipment in all rooms and areas of the household. The equipment should be installed as follows: A smoke detector installed outside of each separate sleeping area, in the immediate vicinity of the bedrooms and on each additional story of the family living unit, including basements and excluding crawl spaces and unfinished attics.

In addition, the NFPA recommends that you install heat or smoke detectors in the living room, dining room, bedroom(s), kitchen, hallway(s), attic, furnace room, utility and storage rooms, basements and attached garages.

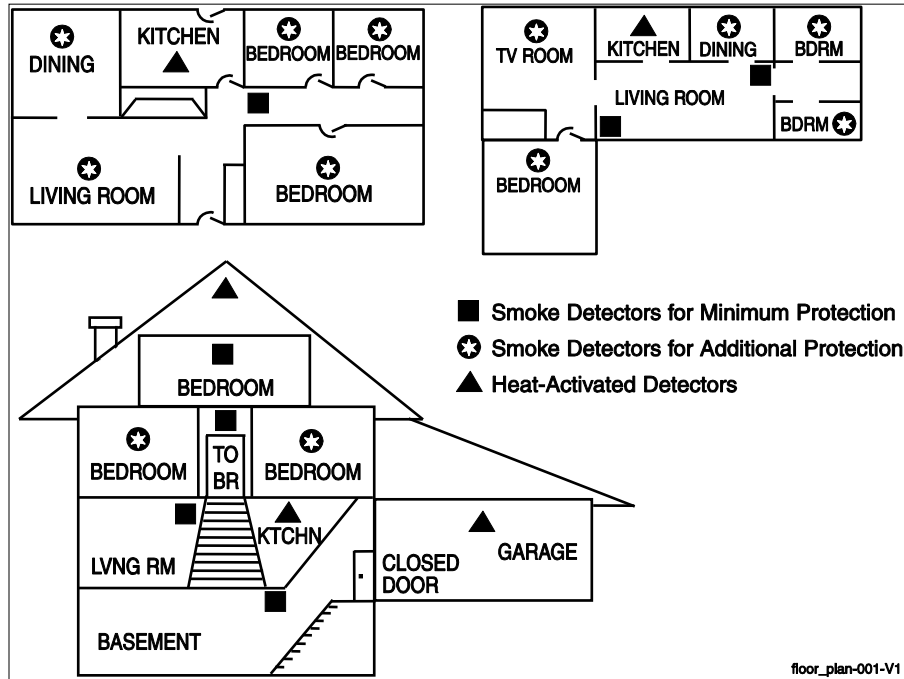

Emergency Evacuation

Establish and regularly practice a plan of escape in the event of fire. The following steps are recommended by the National Fire Protection Association:

1. Position your detector or your interior and/or exterior sounders so that they can be heard by all occupants.
2. Determine two means of escape from each room. One path of escape should lead to the door that permits normal exit from the building. The other should be an alternative escape, such as a window, should your path to that door be impassable. Station an escape ladder at such windows if there is a long drop to the ground.
3. Sketch a floor plan of the building. Show windows, doors, stairs and rooftops that can be used to escape. Indicate escape routes for each room. Keep these routes free from obstruction and post copies of the escape routes in every room.
4. Assure that all bedroom doors are shut while you are asleep. This will prevent deadly smoke from entering while you escape.
5. Try the door. If the door is hot, check your alternate escape route. If the door is cool, open it cautiously. Be prepared to slam the door if smoke or heat rushes in.
6. When smoke is present, crawl on the ground. Do not walk upright, since smoke rises and may overcome you. Clearer air is near the floor.
7. Escape quickly; don't panic.
8. Establish a place outdoors, away from your house, where everyone can meet and then take steps to contact the authorities and account for those missing. Choose someone to assure that nobody returns to the house — many die going back.

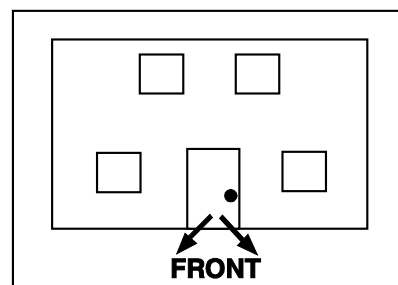
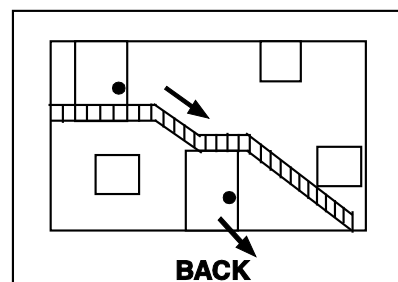
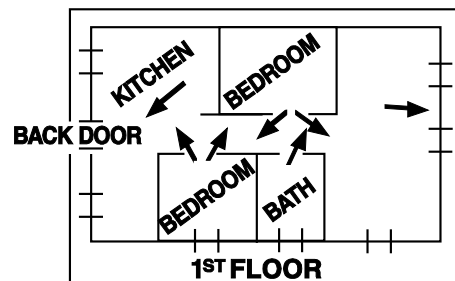
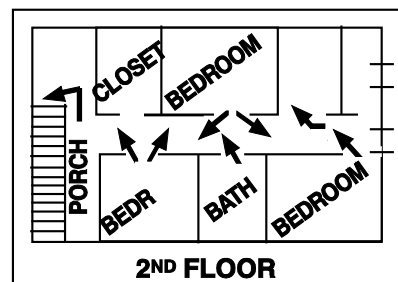

emerevac

Regulatory Agency Statements

FEDERAL COMMUNICATIONS COMMISSION (FCC) & INDUSTRY CANADA (IC) STATEMENTS

The user shall not make any changes or modifications to the equipment unless authorized by the Installation Instructions or User's Manual. Unauthorized changes or modifications could void the user's authority to operate the equipment.

CLASS B DIGITAL DEVICE STATEMENT

This equipment has been tested to FCC requirements and has been found acceptable for use. The FCC requires the following statement for your information:

This equipment generates and uses radio frequency energy and if not installed and used properly, that is, in strict accordance with the manufacturer's instructions, may cause interference to radio and television reception. It has been type tested and found to comply with the limits for a Class B computing device in accordance with the specifications in Part 15 of FCC Rules, which are designed to provide reasonable protection against such interference in a residential installation. However, there is no guarantee that interference will not occur in a particular installation. If this equipment does cause interference to radio or television reception, which can be determined by turning the equipment off and on, the user is encouraged to try to correct the interference by one or more of the following measures:

- If using an indoor antenna, have a quality outdoor antenna installed.
- Reorient the receiving antenna until interference is reduced or eliminated.
- Move the radio or television receiver away from the receiver/control.
- Move the antenna leads away from any wire runs to the receiver/control.
- Plug the receiver/control into a different outlet so that it and the radio or television receiver are on different branch circuits.
- Consult the dealer or an experienced radio/TV technician for help.

INDUSTRY CANADA CLASS B STATEMENT

Cet appareil numérique de la classe B est conforme à la norme NMB-003 du Canada.

FCC / IC STATEMENT

This device complies with Part 15 of the FCC Rules, and Industry Canada's license-exempt RSSs. Operation is subject to the following two conditions: (1) This device may not cause harmful interference, and (2) This device must accept any interference received, including interference that may cause undesired operation.

Cet appareil est conforme à la partie 15 des règles de la FCC et exempt de licence RSS d'Industrie Canada. Son fonctionnement est soumis aux conditions suivantes: (1) Cet appareil ne doit pas causer d'interférences nuisibles. (2) Cet appareil doit accepter toute interférence reçue y compris les interférences causant une réception indésirable.

RF EXPOSURE WARNING

The antenna(s) used for this transmitter must be installed to provide a separation distance of at least 7.8 inches (20 cm) from all persons and must not be co-located or operated in conjunction with any other transmitter except in accordance with FCC and ISED multi-transmitter product procedures.



MISE EN GARDE

Exposition aux Fréquences Radio: La/les antenne(s) utilisée(s) pour cet émetteur doit/doivent être installée(s) à une distance de séparation d'au moins 20 cm (7,8 pouces) de toute personne et ne pas être située(s) ni fonctionner parallèlement à tout autre transmetteur ou antenne, excepté en conformité avec les procédures de produit multi transmetteur FCC et ISED.

IMPORTANT NOTE ABOUT EXTERNAL ANTENNAS

If an external cellular radio antenna is used, the antenna may be installed or replaced ONLY by a professional installer.

To the Installer

PROLTE-A: The external antenna gain shall not exceed 6.63 dBi for 700MHz and 850MHz, 6.0 dBi for 1700MHz and 8.5 dBi for 1900MHz. Under no conditions may an antenna gain be used that would exceed the ERP and EIRP power limits as specified in FCC Parts 22H, 24E and 27.

PROLTE-V: The external antenna gain shall not exceed 6.94 dBi for 700MHz, 6.0 dBi for 1700MHz and 9.01 dBi for 1900MHz. Under no conditions may an antenna gain be used that would exceed the ERP and EIRP power limits as specified in FCC Parts 22H, 24E and 27.

PROLTE-CN: The external antenna gain shall not exceed 6.63 dBi for 700MHz and 850MHz, 6.0 dBi for 1700MHz and 8.51 dBi for 1900MHz. Under no conditions may an antenna gain be used that would exceed the ERP and EIRP power limits as specified IC RSS-130, RSS-132, RSS-133, and RSS-139.

Regulatory Agency Statements (Continued)

OWNER'S INSURANCE PREMIUM CREDIT REQUEST

This form should be completed and forwarded to your homeowner's insurance carrier for possible premium credit.

A. GENERAL INFORMATION:

Insured's Name and Address: _____

Insurance Company: _____ Policy No.: _____

PROA7/PROA7PLUS

_____ Other

Type of Alarm: Burglary Fire Both

Installed by: _____ Serviced by: _____
Name Name

_____ Address Address

B. NOTIFIES (Insert B = Burglary, F = Fire)

Local Sounding Device _____ Police Dept. _____ Fire Dept. _____

Central Station Name: _____

Address: _____

Phone: _____

C. POWERED BY: A.C. with Rechargeable Power Supply

D. TESTING: Quarterly Monthly Weekly Other _____

E. SMOKE DETECTOR LOCATIONS

Furnace Room Kitchen Bedrooms Attic

Basement Living Room Dining Room Hall

F. BURGLARY DETECTING DEVICE LOCATIONS:

Front Door Basement Door Rear Door All Exterior Doors

1st Floor Windows All Windows Interior Locations

All Accessible Openings, Including Skylights, Air Conditioners and Vents

G. ADDITIONAL PERTINENT INFORMATION:

Signature: _____ Date: _____

Your System Information

Your local Resideo dealer is the person best qualified to service your alarm system. Arranging a program of regular service is advisable.

Security Company / Dealer:

Name: _____ Phone: _____

Address: _____

Audio Alarm Verification enabled Yes No
(Two-Way Voice)

PARTITION 1 DELAY DURATIONS AND ARMING OPTIONS

Exit Delay time _____ Entry Delay 1 time _____ Entry Delay 2 time _____

ARM NIGHT enabled Yes No Sensors _____

AUTO HOME enabled Yes No EXIT DELAY RESTART enabled Yes No

QUICK ARM enabled Yes No QUICK EXIT enabled Yes No

CHIME mode enabled Yes No FORCE BYPASS enabled Yes No

Alarm Reporting Delay _____

PARTITION 2 DELAY DURATIONS AND ARMING OPTIONS

Exit Delay time _____ Entry Delay 1 time _____ Entry Delay 2 time _____

ARM NIGHT enabled Yes No Sensors _____

AUTO HOME enabled Yes No EXIT DELAY RESTART enabled Yes No

QUICK ARM enabled Yes No QUICK EXIT enabled Yes No

CHIME mode enabled Yes No FORCE BYPASS enabled Yes No

Alarm Reporting Delay _____

PARTITION 3 DELAY DURATIONS AND ARMING OPTIONS

Exit Delay time _____ Entry Delay 1 time _____ Entry Delay 2 time _____

ARM NIGHT enabled Yes No Sensors _____

AUTO HOME enabled Yes No EXIT DELAY RESTART enabled Yes No

QUICK ARM enabled Yes No QUICK EXIT enabled Yes No

CHIME mode enabled Yes No FORCE BYPASS enabled Yes No

Alarm Reporting Delay _____

PARTITION 4 DELAY DURATIONS AND ARMING OPTIONS

Exit Delay time _____ Entry Delay 1 time _____ Entry Delay 2 time _____

ARM NIGHT enabled Yes No Sensors _____

AUTO HOME enabled Yes No EXIT DELAY RESTART enabled Yes No

QUICK ARM enabled Yes No QUICK EXIT enabled Yes No

CHIME mode enabled Yes No FORCE BYPASS enabled Yes No

Alarm Reporting Delay _____

Your System Information (Continued)

System Users

Keep track of authorized system users in the chart below. This record should be kept secure by the Master User.

User	Code	Authority	Partition	Comment / Description
02		Master User	1, 2, 3, 4	Can add and modify all Users.
03				
04				
05				
06				
07				
08				
09				
10				
11				
12				
13				
14				
15				
16				
17				
18				
19				
20				
21				
22				
23				
24				
25				
26				
27				
28				
29				
30				
31				
32				
33				
34				
35				
36				
37				
38				
39				
40				
41				
42				
43				

Your System Information (Continued)

System Users (Continued)

User	Code	Authority	Partition	Comment / Description
44				
45				
46				
47				
48				
49				
50				
51				
52				
53				
54				
55				
56				
57				
58				
59				
60				
61				
62				
63				
64				
65				
66				
67				
68				
69				
70				
71				
72				
73				
74				
75				
76				
77				
78				
79				
80				
81				
82				
83				
84				
85				
86				
87				

System Users (Continued)

User	Code	Authority	Partition	Comment / Description
88				
89				
90				
91				
92				
93				
94				
95				
96				

Sensor List

Zone	Location / Description
1	
2	
3	
4	
5	
6	
7	
8	
9	
10	
11	
12	
13	
14	
15	
16	
17	
18	
19	
20	
21	
22	
23	
24	
25	
26	
27	
28	
29	
30	

Your System Information (Continued)

Sensor List (Continued)

Zone	Location / Description
31	
32	
33	
34	
35	
36	
37	
38	
39	
40	
41	
42	
43	
44	
45	
46	
47	
48	
49	
50	
51	
52	
53	
54	
55	
56	
57	
58	
59	
60	
61	
62	
63	
64	
65	
66	
67	
68	
69	
70	
71	
72	
73	
74	

Sensor List (Continued)

Zone	Location / Description
75	
76	
77	
78	
79	
80	
81	
82	
83	
84	
85	
86	
87	
88	
89	
90	
91	
92	
93	
94	
95	
96	
97	
98	
99	
100	
101	
102	
103	
104	
105	
106	
107	
108	
109	
110	
112	
113	
114	
115	
116	
117	
118	
119	

Your System Information (Continued)

120	
-----	--

Sensor List (Continued)

Zone	Location / Description
121	
123	
124	
125	
126	
127	
128	
129	
130	
131	
132	
133	
134	
135	
136	
137	
138	
139	
140	
141	
142	
143	
144	
145	
146	
147	
148	
149	
150	
151	
152	
153	
154	
155	
156	
157	
158	
159	
160	
161	
162	
163	
164	

Sensor List (Continued)

Zone	Location / Description
165	
166	
167	
168	
169	
170	
171	
172	
173	
174	
175	
176	
177	
178	
179	
180	
181	
182	
183	
184	
185	
186	
187	
188	
189	
190	
191	
192	
193	
194	
195	
196	
197	
198	
199	
200	
201	
202	
203	
204	
205	
206	
207	

Your System Information (Continued)

Sensor List (Continued)

Zone	Location / Description
208	
209	
210	
211	
212	
213	
214	
215	
216	
217	
218	
219	
220	
221	
222	
223	
224	
225	
226	
227	
228	
229	
230	
231	
232	
233	
234	
235	
236	
237	
238	
239	
240	
241	
242	
243	
244	
245	
246	
247	
248	
249	
250	

Z-Wave Automation Devices

Type	Name	Location
1		
2		
3		
4		
5		
6		
7		
8		
9		
10		
11		
12		
13		
14		
15		
16		
17		
18		
19		
20		
21		
22		
23		
24		
25		
26		
27		
28		
29		
30		
31		
32		
33		
34		
35		
36		
37		
38		
39		
40		
41		
42		

Your System Information (Continued)

Z-Wave Automation Devices (Continued)

Type	Name	Location
43		
44		
45		
46		
47		
48		
49		
50		
51		
52		
53		
54		
55		
56		
57		
58		
59		
60		
61		
62		
63		
64		
65		
66		
67		
68		
69		
70		
71		
72		
73		
74		
75		
76		
77		
78		

Limitations of This Alarm System

WARNING!

While this system is an advanced design security system, it does not offer guaranteed protection against burglary or fire or other emergency. Any alarm system, whether commercial or residential, is subject to compromise or failure to warn for a variety of reasons. For example:

- Intruders may gain access through unprotected openings or have the technical sophistication to bypass an alarm sensor or disconnect an alarm warning device.
- Intrusion detectors (e.g. passive infrared detectors), smoke detectors, and many other sensing devices will not work without power. Battery operated devices will not work without batteries, with dead batteries, or if the batteries are not put in properly. Devices powered solely by AC will not work if their AC power supply is cut off for any reason, however briefly.
- Signals sent by wireless transmitters may be blocked or reflected by metal before they reach the alarm receiver. Even if the signal path has been recently checked during a weekly test, blockage can occur if a metal object is moved into the path.
- A user may not be able to reach a panic or emergency button quickly enough.
- While smoke detectors have played a key role in reducing residential fire deaths in the United States, they may not activate or provide early warning for a variety of reasons in as many as 35% of all fires, according to data published by the Federal Emergency Management Agency. Some of the reasons smoke detectors used in conjunction with this System may not work are as follows. Smoke detectors may have been improperly installed and positioned. Smoke detectors may not sense fires that start where smoke cannot reach the detectors, such as in chimneys, in walls, or roofs, or on the other side of closed doors. Smoke detectors also may not sense a fire on another level of a residence or building. A second floor detector, for example, may not sense a first floor or basement fire. Moreover, smoke detectors have sensing limitations. No smoke detector can sense every kind of fire every time. In general, detectors may not always warn about fires caused by carelessness and safety hazards like smoking in bed, violent explosions, escaping gas, improper storage of flammable materials, overloaded electrical circuits, children playing with matches, or arson. Depending upon the nature of the fire and/or the locations of the smoke detectors, the detector, even if it operates as anticipated, may not provide sufficient warning to allow all occupants to escape in time to prevent injury or death.
- Passive Infrared Motion Detectors can only detect intrusion within the designed ranges as diagrammed in their installation manual. Passive Infrared Detectors do not provide volumetric area protection. They do create multiple beams of protection, and intrusion can only be detected in unobstructed areas covered by those beams. They cannot detect motion or intrusion that takes place behind walls, ceilings, floors, closed doors, glass partitions, glass doors, or windows. Mechanical tampering, masking, painting or spraying of any material on the mirrors, windows or any part of the optical system can reduce their detection ability. Passive Infrared Detectors sense changes in temperature; however, as the ambient temperature of protected area approaches the temperature range of 90° to 105°F, the detection performance can decrease.
- Alarm warning devices such as sirens, bells or horns may not alert people or wake up sleepers if they are located on the other side of closed or partly open doors. If warning devices sound on a different level of the residence from the bedrooms, then they are less likely to waken or alert people inside the bedrooms. Even persons who are awake may not hear the warning if the alarm is muffled from a stereo, radio, air conditioner or other appliance, or bypassing traffic. Finally, alarm warning devices, however loud, may not warn hearing-impaired people or waken deep sleepers.
- Communication paths needed to transmit alarm signals from premises to a central monitoring station may be out of service or temporarily out of service. Communication paths are also subject to compromise by sophisticated intruders.
- Even if the system responds to the emergency as intended, however, occupants may have insufficient time to protect themselves from the emergency situation. In the case of a monitored alarm system, authorities may not respond appropriately.
- This equipment, like other electrical devices, is subject to component failure. Even though this equipment is designed to last as long as 10 years, the electronic components could fail at any time.

The most common cause of an alarm system not functioning when an intrusion or fire occurs is inadequate maintenance. This alarm system should be tested weekly to make sure all sensors and transmitters are working properly.

Installing an alarm system may make one eligible for lower insurance rates, but an alarm system is not a substitute for insurance. Homeowners, property owners and renters should continue to act prudently in protecting themselves and continue to insure their lives and property.

We continue to develop new and improved protection devices. Users of alarm systems owe it to themselves and their loved ones to learn about these developments.



The product should not be disposed of with other household waste. Check for the nearest authorized collection centers or authorized recyclers. The correct disposal of end-of-life equipment will help prevent potential negative consequences for the environment and human health.

Any attempt to reverse-engineer this device by decoding proprietary protocols, de-compiling firmware, or any similar actions is strictly prohibited.

For Warranty information, visit: www.security.honeywellhome.com/warranty



resideo

www.resideo.com

Resideo Technologies, Inc
2 Corporate Center Drive, Suite 100
P.O. Box 9040, Melville, NY 11747

© 2020 Resideo Technologies, Inc. All rights reserved.

The Honeywell Home trademark is used under license from Honeywell International, Inc.

This product is manufactured by Resideo Technologies, Inc. and its affiliates.



800-25080A 10/20 Rev A